



CIVIL ENGINEERING STUDIES
Illinois Center for Transportation Series No. 14-004
UILU-ENG-2014-2004
ISSN: 0197-9191

EFFECTS OF VARIOUS ASPHALT BINDER ADDITIVES/MODIFIERS ON MOISTURE- SUSCEPTIBLE ASPHALTIC MIXTURES

Prepared By
Imad L. Al-Qadi
Ibrahim M. Abuawad
Heena Dhasmana
Aaron R. Coenen
University of Illinois at Urbana-Champaign

James S. Trepanier
Illinois Department of Transportation

Research Report FHWA-ICT-14-004

A report of the findings of
ICT-R27-078
**Effects of Various Asphalt Binder Additives/Modifiers
on Moisture-Susceptible Asphaltic Mixtures**

Illinois Center for Transportation

January 2014

Technical Report Documentation Page

1. Report No. FHWA-ICT-14-004		2. Government Accession No.		3. Recipient's Catalog No.	
4. Title and Subtitle Effects of Various Asphalt Binder Additives/Modifiers on Moisture-Susceptible Asphaltic Mixtures				5. Report Date January 2014	
				6. Performing Organization Code	
7. Author(s) Imad L. Al-Qadi, Ibrahim M. Abuawad, Heena Dhasmana, Aaron R. Coenen, and James S. Trepanier				8. Performing Organization Report No. ICT-14-004 UILU-ENG-2014-2004	
9. Performing Organization Name and Address Illinois Center for Transportation Department of Civil and Environmental Engineering University of Illinois at Urbana-Champaign 205 N. Mathews Ave., MC 250 Urbana, IL 61801				10. Work Unit No. (TRAIS)	
				11. Contract or Grant No. R27-78	
12. Sponsoring Agency Name and Address Illinois Department of Transportation Bureau of Materials and Physical Research 126 E. Ash Street Springfield, IL 62704				13. Type of Report and Period Covered	
				14. Sponsoring Agency Code	
15. Supplementary Notes					
16. Abstract Moisture damage of asphalt concrete is defined as the loss of strength and stability caused by the active presence of moisture. The most common technique to mitigate moisture damage is using additives or modifiers with the asphalt binder or the aggregate. Various additives and modifiers are used to enhance the performance of asphalt mixtures. However, some of these additives/modifiers may affect the moisture susceptibility of the asphaltic mixtures. The objective of this study was to investigate the effect, if any, of various additives and modifiers on the moisture susceptibility of asphalt concrete. Additives and modifiers included in this study were selected as those most commonly used in Illinois: liquid anti-strip (LAS), styrene butadiene styrene (SBS), polyphosphoric acid (PPA), and hydrated lime. Two mixtures exhibiting failed tensile strength ratio (TSR) results were selected for testing. Mixture-level lab tests were conducted including modified AASHTO T283 Lottman test with five freezing and thawing (FT) cycles, the Hamburg wheel tracking test, and a fracture test using semi-circular bending (SCB) specimens. The modified AASHTO T283 Lottman tests showed that LAS and hydrated lime improved moisture damage control of the asphalt mixes. In the wheel tracking tests, mixes with SBS-modified binder and mixes with hydrated lime provided the least rutting potential. The fracture tests generally showed that mixes with either hydrated lime or LAS had the best relative performance. Component-level tests were conducted including the direct adhesion test (DAT) and contact angle test to determine surface free energy (SFE). Results of SFE values and DAT parameters were in agreement with the results of mixture-level tests: LAS and hydrated lime generally help to mitigate a mixture's susceptibility to moisture. Full-scale test sections were built and exposed to accelerated load testing. Although not all full-scale sections met the lab-mix design volumetrics, the control mix and the mixes with LAS and SBS had similar mixture composition compared with the lab-prepared mixes. This study found that LAS and hydrated lime might reduce moisture susceptibility of asphalt mixes. However, PPA may need to be used with another moisture control additive or modifier in order to avoid adverse effects on an asphalt mixture. The study also found that surface free energy values can be used to identify aggregate-binder compatibility with respect to moisture damage.					
17. Key Words Moisture damage, asphalt concrete, additives, modifiers, and surface energy			18. Distribution Statement No restrictions. This document is available to the public through the National Technical Information Service, Springfield, Virginia 22161		
19. Security Classif. (of this report) Unclassified		20. Security Classif. (of this page) Unclassified		21. No. of Pages 56 plus appendix	22. Price

ACKNOWLEDGMENTS

This publication is based on the results of ICT R27-78, **Effects of Various Asphalt Binder Additives/Modifiers on Moisture-Susceptible Asphaltic Mixtures**. ICT R27-78 was conducted in cooperation with the Illinois Center for Transportation; the Illinois Department of Transportation, Division of Highways; and the U.S. Department of Transportation, Federal Highway Administration.

Members of the Technical Review Panel were the following:

James Trepanier, Chair, Illinois Department of Transportation

Abdul Dahhan, Illinois Department of Transportation

Mel Kirchler, Illinois Department of Transportation

Pat Koester, Howell Paving

Matt Mueller, Illinois Department of Transportation

Bill Pine, Heritage Construction and Materials

Kyle Videgar, Illinois Department of Transportation

Hal Wakefield, Federal Highway Administration, Illinois Division

Tom Zehr, Illinois Department of Transportation

DISCLAIMER

The contents of this report reflect the view of the authors, who are responsible for the facts and the accuracy of the data presented herein. The contents do not necessarily reflect the official views or policies of the Illinois Center for Transportation, the Illinois Department of Transportation, or the Federal Highway Administration. This report does not constitute a standard, specification, or regulation.

EXECUTIVE SUMMARY

Moisture damage of asphalt concrete is defined as the loss of strength and stability caused by the active presence of moisture. The most common technique to mitigate moisture damage is the use of additives or modifiers with the asphalt binder or the aggregate.

The objective of this study was to investigate the effect of various additives and modifiers on moisture susceptibility of asphalt concrete. The additives and modifiers selected for study were liquid anti-strip (LAS), styrene butadiene styrene (SBS), polyphosphoric acid (PPA), and hydrated lime. Two moisture-susceptible mixes were selected for testing. Tests at both mixture and component levels were conducted to evaluate the impact of these additives and modifiers on mixture moisture damage. The mixture-level lab tests included the modified AASHTO T283 Lottman test with five freezing and thawing (FT) cycles, the wheel tracking test, and a fracture test using semi-circular bending (SCB) specimens. The component-level tests included the direct adhesion test (DAT) and surface free energy (SFE) test.

The modified AASHTO T283 Lottman tests showed that LAS and hydrated lime improved moisture resistance of the asphalt mixes. In the wheel tracking tests, mixes with SBS-modified asphalt binder and mixes with hydrated lime provided the least rutting potential. The fracture tests generally showed that mixes with either hydrated lime or LAS had the best relative performance. Results of SFE tests and DATs were in agreement with the results of mixture-level tests: LAS and hydrated lime can mitigate a mixture's susceptibility to moisture. Full-scale test sections were built and exposed to accelerated load testing. Although not all full-scale sections met the lab-mix design volumetric requirements, the control mix and mixes with LAS and SBS (independently) exhibited similar performance when compared with the lab mixes.

This study found that adding freezing and thawing cycles to asphalt mixture conditioning results in significant moisture damage of specimens. In addition, LAS and hydrated lime can be effective in controlling moisture damage when used with moisture-susceptible mixes. However, PPA may need to be used with another moisture control additive or modifier because it adversely affected moisture susceptibility when compared with the control mix. The study also found that the surface free energy test is feasible for identifying aggregate–asphalt binder compatibility with respect to moisture damage. Accordingly, the research team recommends that

- Illinois should maintain its specification restricting the addition of LAS that improves the tensile strength ratio of asphalt mixture but reducing its conditioned strength. An indirect tensile strength threshold for unconditioned specimens should be added to the specifications. An optimized dosage should be identified for the selected LAS.
- LAS or hydrated lime can be used to control moisture damage in asphalt concrete mixes in Illinois.
- The applicability of surface free energy should be further investigated as a possible compatibility test to prevent potential moisture damage.

CONTENTS

CHAPTER 1	INTRODUCTION.....	1
1.1	BACKGROUND	1
1.2	MOISTURE DAMAGE EVALUATION OF ASPHALT CONCRETE.....	2
CHAPTER 2	LABORATORY INVESTIGATION	4
2.1	ASPHALT MIXES.....	4
2.2	MATERIAL DEFINITIONS.....	5
2.2.1	Liquid Anti-Strip	5
2.2.2	Styrene Butadiene Styrene (SBS)	5
2.2.3	Polyphosphoric Acid (PPA).....	6
2.2.4	Hydrated Lime	6
2.3	LABORATORY TESTS	7
2.3.1	Illinois Modified Lottman AASHTO T283 Test.....	7
2.3.2	Lottman AASHTO T283 Test with Five Freeze–Thaw Cycles.....	8
2.3.3	Wheel Tracking Test.....	9
2.3.4	Fracture Test (SCB Specimens).....	9
2.4	TEST RESULTS and DISCUSSION.....	11
2.4.1	Illinois Modified Lottman AASHTO T283-02 Test.....	12
2.4.2	Lottman AASHTO T283 Test with Five Freeze–Thaw Cycles.....	13
2.4.3	Wheel Tracking Test.....	16
2.4.4	Fracture Test (SCB Specimens).....	18
2.5	SUMMARY, FINDINGS, and RECOMMENDATIONS	19
2.5.1	Findings.....	19
2.5.2	Recommendations.....	20
CHAPTER 3	ACCELERATED PAVEMENT TESTING	22
3.1	PAVEMENT SECTIONS	22
3.2	APT FACILITY	23
3.3	CONSTRUCTION SITE	23
3.4	TESTING DESCRIPTION	25
3.5	APT RESULTS.....	25

3.5.1 Extraction of Field Cores	27
3.5.2 APT Section Rutting Measurements	34
3.5.3 Lab Testing on Field Loose Mix Samples	35
3.6 Summary.....	37
CHAPTER 4 COMPONENT-LEVEL TESTING	38
4.1 MATERIAL CHARACTERISTICS.....	38
4.2 COMPONENT-LEVEL TESTS	38
4.2.1 Surface Free Energy (SFE) Test	38
4.2.2 Direct Adhesion Test (DAT).....	44
4.3 TEST RESULTS AND DISCUSSION	46
4.3.1 Surface Free Energy (SFE) Test	47
4.3.2 Direct Adhesion Test (DAT).....	49
4.4 FINDINGS.....	49
4.5 RECOMMENDATIONS	50
CHAPTER 5 SUMMARY, CONCLUSIONS, AND RECOMMENDATIONS	51
5.1 SUMMARY.....	51
5.2 FINDINGS.....	51
5.3 CONCLUSIONS.....	52
5.4 RECOMMENDATIONS	53
REFERENCES	54
APPENDIX A LITERATURE REVIEW	57

CHAPTER 1 INTRODUCTION

1.1 BACKGROUND

Moisture damage is the loss of strength and stiffness of asphalt mixtures caused by the existence of moisture (Huang et al. 2009; Bhasin et al. 2007). The propagation of moisture damage generally occurs through two main mechanisms: the loss of adhesion (stripping) and loss of cohesion (softening) (Izzo and Tahmooressi 1999; Wasiuddin et al. 2007a; Cheng et al. 2003; Sebaaly et al. 2007; Hao and Liu 2006). The loss of adhesion occurs between the aggregate and surrounding asphalt binder film, while the loss of cohesion occurs within the asphalt binder itself. Although moisture damage is not a failure mode, it leads to and accelerates several pavement distresses such as rutting, raveling, shoving, and bleeding (Wasiuddin et al. 2007a; Sebaaly, Hitti, and Weitzel 2003).

Moisture damage results in annual expenditures of billions of dollars by transportation agencies through additional vehicle operating costs and maintenance and reconstruction costs (Izzo and Tahmooressi 1999; Caro et al. 2008a). Several factors control the moisture susceptibility of asphalt mixtures; these factors are related to the compatibility between aggregate and asphalt binder and also to the moisture and drainage conditions within the pavement (Mallick, Pelland, and Hugo 2005).

The use of various additives and modifiers in an asphalt mixture is one of the most popular, cost-effective measures adopted by transportation agencies to mitigate moisture damage. These additives can be found naturally or are chemically processed. These additives and modifiers are either added to asphalt binder or aggregate. Additives and modifiers are added to asphalt binder, while Portland cement and hydrated lime are added to the aggregate (Huang et al. 200; Sebaaly et al. 2007; Hao and Liu 2006; Lu and Harvey 2006). In general, there are three forms of asphalt binder modification (Bhasin and Little 2009):

- Performance grade (PG) modification: Polymers are added to the asphalt binder to increase its PG, especially the high-temperature range.
- Mixture performance modification: Special material, such as liquid anti-strip (LAS) agent, is added to the asphalt binder to enhance asphalt mixture performance.
- Environmental modification, such as asphalt concrete aging: Aging leads to changes in the chemistry and mechanical properties of asphalt binder.

The first and the second types of modification increase the bond energy between the asphalt binder and aggregate by decreasing the surface tension of asphalt binder or aggregate (Expert Task Group 1990). Additives such as hydrated lime can be added to either asphalt binder or aggregate. Usually, the improvement of moisture resistance brought about by the addition of these additives and modifiers is the result of an enhanced bond between aggregate and asphalt binder (Chen, Tayebali, and Knappe 2006). The aggregate–asphalt binder bond is enhanced through one of three main mechanisms: improvement of aggregate surface; reduction of asphalt binder surface tension, which promotes asphalt binder spreading through the aggregate; and improvement of chemical properties of both aggregate and asphalt binder.

If an additive or a modifier is used to enhance moisture resistance, three main factors should be taken into consideration: dosage, cost and other economic factors, and effect of the modification on adhesive and other mixture properties (Expert Task Group 1990). In this study, the effects of two additives and two modifiers on moisture susceptibility were studied. The

additives are hydrated lime and LAS, and the two modifiers are styrene butadiene styrene (SBS) and polyphosphoric acid (PPA)

1.2 MOISTURE DAMAGE EVALUATION OF ASPHALT CONCRETE

The evaluation of moisture damage in asphalt mixtures is a major challenge for transportation agencies (Izzo and Tahmooressi 1999). This is because moisture damage is a complex phenomenon that encompasses physical, mechanical, chemical, and thermodynamic processes (Caro et al. 2008a). The three primary causes of moisture movement through asphalt concrete are the permeability of surface water, suction (capillary rise and osmotic effect), and water vapor diffusion. The movement mechanism of moisture within asphalt binder or mastic is called diffusion. Diffusion is considered an asphalt binder property. Generally, if moisture diffuses through the mastic toward the aggregate–asphalt binder interface, it will cause an adhesion failure, but if moisture diffuses in the asphalt binder, it may cause a cohesive failure. Hence, to fully study moisture damage, it is important to develop a set of tests to evaluate moisture damage at both mixture and component level that are capable of quantifying the effect of various additives on moisture-sensitive mixes.

Laboratory tests for moisture damage can be classified in many ways. Caro et al. (2008a) established a traditional classification based on sample description, sample conditioning process, loading type (static or dynamic), and measured scale of performance (micro- and macroscale). Sample condition classification divides the aforementioned tests into three groups (Cho and Bahia 2007): tests on compacted samples, such as the Marshall stability test; tests on loose mixture samples, such as the water immersion method; and tests on the components of the asphalt mixture (aggregate and asphalt binder), such as the dynamic Wilhelmy plate method.

Several tests have been developed to perform this evaluation at the mixture level. Development of these tests began in the early 20th century and is ongoing. These tests have improved through the years, starting with the boil test in the 1930s up to recent tests such as wheel track and Lottman (Tarefder and Zaman 2010). The mixture-level tests use several approaches to accelerate the moisture effect on asphalt mixtures, such as placing samples in the freezer or in hot water, vacuum-saturating asphalt concrete samples, and boiling loose mixtures (Birgisson et al. 2007). These tests allow estimation of the stripping potential that occurs between aggregate and asphalt binder and the amount of strength lost in asphalt mixtures caused by the conditioning process (Izzo and Tahmooressi 1999).

Regardless of whether the asphalt mixture sample is loose or compacted, it should undergo a conditioning process. The conditioning process that the asphalt sample undergoes before testing affects the outcomes of the applied test. The most widely used conditioning processes are boiling loose samples, vacuum-saturating compacted samples, placing compacted samples in a water bath, or applying freezing and thawing (FT) cycles on compacted samples, then loading them to simulate traffic loads (Birgisson et al. 2007).

Most of the early tests for quantifying moisture damage concentrated on comparing mechanical properties before and after a conditioning process (Bhasin et al. 2007). There are three problems with this approach. First, it doesn't capture the real cause of moisture damage nor does it identify the effects of the components and mixture properties on this phenomenon (Bhasin et al. 2007). Second, it doesn't simulate actual field conditions acting on asphalt concrete mixtures, such as environmental conditions, traffic, and time (Terrel and Al-Swailmi 1994); therefore, the results are poorly correlated with field performance (Caro et al. 2008a, 2008b). Third, most of the procedures used in these early tests were empirical, and results varied based on the moisture-conditioning method used (Caro et al. 2008a).

An expert task group (ETG) of the Federal Highway Administration (FHWA) authored a comprehensive state-of-the-art report on moisture damage that evaluated different aspects of moisture damage and the tests that can be used to evaluate such damage. According to “Moisture Damage in Asphalt Mixtures—A State-of-the-Art Report,” it is difficult to develop a test that accurately evaluates moisture damage and simulates field performance for two reasons: first, the moisture damage phenomenon involves physical, mechanical, and chemical processes; second, moisture damage is dependent on variables that are time dependent, such as asphalt binder properties.

The aforementioned drawbacks and challenges motivated researchers to develop additional reliable mixture-level tests. Simultaneously, researchers established a new set of tests that evaluate moisture susceptibility at the component level. Asphalt binder and aggregate are the two common asphalt concrete components. The new tests concentrated on the components of the asphalt mixtures (i.e., asphalt binder and aggregate) by examining their properties and analyzing them to better understand and characterize the moisture damage phenomenon and how various additives and modifiers work in mitigating moisture damage (Terrel and Al-Swailmi 1994; Caro 2009). Component-level tests are more accurate than mixture tests in determining the primary cause of moisture-related failure. Surface free energy, adhesion, cohesion, and complex shear modulus are various types of component parameters that can be used.

Mathematical modeling is another new approach that contributes to evaluating and understanding moisture damage (Caro et al. 2008a). Modeling of moisture damage is only possible because of state-of-the-art computing programs and an understanding of the chemical and physical processes of moisture damage. Mathematical modeling could make it possible to predict the behavior of asphalt concrete in the presence of moisture for any given environmental and traffic loading conditions (Kringos et al. 2008a). Through computer modeling, the effects of moisture on asphalt binder, aggregate, and mixture properties can be determined (Caro et al. 2008b). Two primary factors related to moisture damage can be modeled: moisture transport and the mechanism of failure modes. The Delft University of Technology in the Netherlands developed a finite element routine called raveling of asphalt mixes (RoAM) (Kringos et al. 2008a, 2008b). In that routine, its founders conducted a numerical simulation of diffusion that resulted in adhesive failure, cohesive failure, and washing-away failure. The routine also simulates the pumping action failure mode. RoAM is used exclusively for modeling and analyzing moisture damage.

X-ray computed tomography (CT) technology, along with techniques related to imaging analysis, has been utilized to model the various modes of moisture transport. The finite difference techniques and the Lattice Boltzmann approach were used to model permeability or moisture flow (Caro et al. 2008b). Both approaches can provide flow speed and pore pressure at any point along the void structure of asphalt concrete. The microscale finite element model has been used to simulate moisture-induced damage caused by moisture diffusion or permeability.

It is evident that mixture-level testing can provide a good qualitative indication of effect of additives and modifiers on moisture damage potential. Using testing at the component level, however, can provide a more scientific and rigorous approach when combined with mixture-level tests. On the other hand, modeling of the moisture phenomenon must be further studied, analyzed, and developed. Other factors can be introduced in the future modeling process, such as simulating the effect of additives on asphalt mixtures, involving more components and mixture properties related to moisture damage, and simultaneous environmental and traffic loading conditions.

CHAPTER 2 LABORATORY INVESTIGATION

In this study, a detailed laboratory investigation was undertaken. The laboratory investigation focused on the effect of selected additives and modifiers when added to two moisture-susceptible asphalt mixes. The laboratory tests discussed in this chapter were conducted on the mixtures. This chapter covers the following:

- Asphalt mixes
- Selected additives and modifiers
- Laboratory tests
- Laboratory tests results and discussion

2.1 ASPHALT MIXES

Two mixes from IDOT District 5 were chosen for this study. These mixes are designated N70 and N90. The numbers 70 and 90 represent the design number of gyrations. The mixes were chosen because they are moisture susceptible, as indicated by tensile strength ratio (TSR) results. N70 uses four aggregate stockpiles—two coarse (CM11 and CM16) and two fine (FM20 and FM02). The CM11, CM16, and FM20 were imported from a quarry in Kankakee, Illinois, and are considered to be dolomitic limestone, while FM02 is a type of natural sand (combination of siliceous and carbonate) imported from Mahomet, Illinois. N90 uses CM11, CM16, and FM20. The current state of knowledge in the literature suggests that dolomitic limestone generally produces asphalt concrete that is relatively unsusceptible to stripping. In addition to these aggregate stockpiles, mineral filler imported from Thornton, Illinois, was used in both the N70 and N90 mixes. Table 2.1 presents the aggregate gradations and some physical properties of the aggregates.

Table 2.1 Aggregate Main Features: (a) Gradations, (b) Aggregate Physical Properties

(a)

Sieve Size	Aggregate				
	CM11	CM16	FM20	FM02	MF
1"	100.0	100.0	100.0	100.0	100.0
3/4"	82.1	100.0	100.0	100.0	100.0
1/2"	39.1	100.0	100.0	100.0	100.0
3/8"	19.0	97.3	100.0	100.0	100.0
No. 4	3.9	36.7	98.6	96.1	100.0
No. 8	2.7	6.8	74.6	88.0	100.0
No. 16	2.4	3.1	43.9	77.4	100.0
No. 30	2.2	2.3	24.6	64.2	100.0
No. 50	2.1	2.2	14.5	25.2	100.0
No. 100	2.1	2.1	9.7	2.5	95.0
No. 200	2.0	2.0	7.1	0.9	90.0

(Table 2.1 continues, next page)

Table 2.1 (continued from previous page)

(b)

Parameter	Aggregate				
	CM11	CM16	FM20	FM02	MF
Bulk Spec Gravity	2.632	2.620	2.635	2.551	2.9
Absorption (%)	2.0	2.6	2.1	1.6	1.0
Loose Weight (Avg)	1450.4	1435.1	1628.8	1649.7	—
Rodded Weight (Avg)	1610.0	1574.3	1824.9	1784.4	—
Solid Unit Weight	2632.0	2620.0	2635.0	2551.0	—
Voids at Loose UW (%)	44.9	45.2	38.2	0.4	—
Voids at Rodded UW (%)	38.8	39.9	30.7	0.3	—

2.2 MATERIAL DEFINITIONS

The selected additives and modifiers tested in this project to determine their direct or indirect effect on moisture damage were liquid anti-strip (LAS), styrene butadiene styrene (SBS), polyphosphoric acid (PPA), and hydrated lime. Each additive or modifier was incorporated into asphalt binder or mixture to enhance certain properties, as detailed below. The purpose of this study is to determine the effect that incorporation of each commonly used additive or modifier has on the moisture susceptibility/sensitivity of asphalt mixtures, regardless of the reason for incorporating each additive.

2.2.1 Liquid Anti-Strip

One of the most popular approaches for mitigating moisture susceptibility of asphalt mixes is adding LAS to asphalt binder. LAS's are surface active agents that can be added to asphalt binder, emulsion, and cutbacks. Generally, LAS's reduce the surface tension and increase the wettability of aggregates, which produces better adhesion between the asphalt binder and aggregate surface. The selection of the most effective LAS product is time consuming and no selection guidelines are available with respect to asphalt concrete composition. For this project, an anti-strip used by local contractors was selected and dosage was optimized. Appropriate dosage of LAS's added to asphalt binder falls in the range of 0.1% to 3% (Expert Task Group 1990). The challenges inherent in using LAS in asphalts include thermal degradation, long-term field performance, and heat instability (Wasiuddin et al. 2007b). Four LAS amounts (0.25%, 0.50%, 0.75%, and 1.0%) were used to determine the optimum LAS content for the N70 and N90 mixes. Mixes with each dosage of LAS were tested after the Lottman AASHTO T283 test with five FT cycles.

2.2.2 Styrene Butadiene Styrene (SBS)

SBS is a thermoplastic polymer that improves the overall performance of asphalt pavement by reducing potential rutting in summer and cracking in winter by increasing the stability, elasticity, and stiffness of asphalt binders (Tarefder and Zaman 2010). SBS softens under high temperature; therefore, it can be easily added and mixed with asphalt binder. The effect of SBS-modified binders on moisture sensitivity remains undetermined. It has not yet been confirmed whether SBS modification increases or decreases the moisture damage potential (Tarefder and Zaman 2010). In the current study, 1.5% SBS was added to PG 64-22 by the weight of asphalt binder to bump the grade to PG 70-22.

2.2.3 Polyphosphoric Acid (PPA)

PPA is a liquid mineral polymer that has many applications in industry, including as a modifier to asphalt binder to reduce or slow the effects of oxidative aging undergone by bituminous materials. PPA is a modifier that needs more evaluation, especially in determining its impact on moisture damage to asphalt concrete. PPA can be used alone or with other additives such as hydrated lime or LAS and also with polymers such as SBS. Another important aspect of PPA is that it does not react efficiently with limestone aggregates; at the same time, however, it is efficient with acidic aggregate such as granite (Buncher 2010; TFHRC 2010). In this study, 1.25% PPA was added to PG 64-22 by the weight of asphalt binder to bump the asphalt binder grade to PG 70-22.

2.2.4 Hydrated Lime

One of the early approaches to mitigate moisture susceptibility of asphalt mixes is the use of hydrated lime additive. Hydrated lime is thought to improve the stripping resistance of the asphalt mix by two methods: first by increasing the adhesion energy between the aggregate and asphalt binder, and second by decreasing the interfacial tension between the asphalt binder and water. The hydrated lime reacts with the carboxylic acids in asphalt binder, forming insoluble compounds that are absorbed onto the aggregate surface. Hydrated lime dosage usually falls in a range of 0.5% to 2% by the weight of the aggregate (Expert Task Group 1990). Four methods for adding hydrated lime to asphalt mixtures were used in this study:

- Hydrated lime slurry: Slurry is a combination of water and hydrated lime. The water, according to IDOT specifications, should be approximately 3% by weight of dry aggregate. Hydrated lime content is measured by weight of dry aggregate. Slurry is added to the aggregate in its saturated surface dry (SSD) condition. The aggregate with slurry is immediately placed in an oven at $230 \pm 9^\circ\text{F}$ ($110 \pm 5^\circ\text{C}$) until the sample weight is constant, then the oven temperature is increased to the mixing temperature of $295 \pm 5^\circ\text{F}$ ($146 \pm 3^\circ\text{C}$) for 2 hr. The normal mixing and compaction process is then followed.
- Hydrated lime slurry with marination: The procedure used for hydrated lime slurry with marination is the same as for hydrated lime slurry except that after adding slurry to the SSD aggregate, the sample is left for 24 hr to marinate. Then the sample is placed in an oven at $295 \pm 5^\circ\text{F}$ ($146 \pm 3^\circ\text{C}$) for 2 hr. The normal mixing and compaction process is then followed.
- Dry hydrated lime to dry aggregate: In this method, hydrated lime is added to aggregate preheated for 2 hr at a mixing temperature of $295 \pm 5^\circ\text{F}$ ($146 \pm 3^\circ\text{C}$). The blend of aggregate and hydrated lime is placed back in the oven until the temperature returns to the mixing temperature. Asphalt binder is added to the blend, and the normal mixing and compaction process is then followed.
- Dry hydrated lime with moist aggregate: The difference between this method and the dry hydrated lime to dry aggregate method is that the dry hydrated lime is added to SSD aggregate as in the case of preparing hydrated lime slurry. The sample is then placed in the oven at $230 \pm 9^\circ\text{F}$ ($110 \pm 5^\circ\text{C}$) until the sample weight is constant, then the oven temperature is increased to $295 \pm 5^\circ\text{F}$ ($146 \pm 3^\circ\text{C}$) for 2 hr. The normal mixing and compaction process is then followed.

2.3 LABORATORY TESTS

This study used the following four tests to evaluate the moisture susceptibility of the different asphalt mixtures:

- Illinois modified Lottman AASHTO T283-02 test
- Lottman AASHTO T283-02 test with five FT cycles
- Wheel tracking test
- Fracture test using semi-circular bend (SCB) specimens

The Illinois modified Lottman AASHTO T283-02 test was performed on the N70 and N90 control mixes only. The other three tests were performed on all considered mixtures (N70 and N90 controls, LAS, SBS, and PPA asphalt mixes).

2.3.1 Illinois Modified Lottman AASHTO T283 Test

To evaluate whether the selected N70 and N90 mixes are moisture susceptible, the Illinois modified Lottman test was conducted. This test is a modified version of the Lottman AASHTO T283 test; Illinois DOT modified the test procedure by altering the sample conditioning process by excluding the single freeze–thaw cycle. Illinois DOT has found that conditioning with a 24 hr soak in the 140°F (60°C) bath alone proves to be a more rigorous conditioning than the inclusion of a single freeze–thaw cycle (i.e., it more significantly affects results compared with unconditioned mixes).

Each mix requires six specimens. The dimension of each specimen was 150 mm (5.91 in) in diameter and 3.75 ± 0.20 in (95 ± 5 mm) in thickness. The air void content of each specimen should be $7.0\% \pm 0.5\%$. The six specimens were divided into two groups: unconditioned and conditioned sets. The average air void content for each set should be approximately the same.

Before the unconditioned set of mixtures were tested for indirect tensile (IDT) strength, they were placed in a $77 \pm 1.8^\circ\text{F}$ ($25 \pm 1^\circ\text{C}$) water bath for $2 \text{ hr} \pm 10 \text{ min}$ with at least 1 in (25 mm) of water covering the specimens' surface. The conditioning process starts by saturating each specimen to between 70% and 80% of its air voids under a vacuum of 10 to 26 in Hg partial pressure (13 to 67 kPa absolute pressure). Then the conditioned set of specimens were placed in a $140 \pm 1.8^\circ\text{F}$ ($60 \pm 1^\circ\text{C}$) water bath for $24 \pm 1 \text{ hr}$. The final step is to transfer the specimens to a $77 \pm 1.8^\circ\text{F}$ ($25 \pm 1^\circ\text{C}$) water bath for $2 \text{ hr} \pm 10 \text{ min}$. The conditioned specimens are then tested for their IDT strength, as shown in Figure 2.1.

The average IDT strength was calculated for the unconditioned and conditioned sets in order to calculate the tensile strength ratio (TSR) parameter. The TSR is the ratio of the average IDT strength of conditioned specimens to the average IDT strength of unconditioned specimens, as shown in Equation 2.1.

$$TSR(\%) = \frac{IDT_W}{IDT_D} \times 100 \quad (2.1)$$

where

- TSR = tensile strength ratio
- IDT_W = average indirect tensile strength for the conditioned set
- IDT_D = average indirect tensile strength for the unconditioned set

According to IDOT specifications the TSR threshold is 85%. In the event the mix has a TSR lower than 85%, the mixture is considered moisture susceptible or prone to stripping. Also, the minimum acceptable IDT strength is 60 psi (413.7 kPa) and 80 psi (551.6 kPa) for unmodified and modified asphalt binder, respectively. The minimum IDT strength is applicable for both unconditioned and conditioned specimens.



Figure 2.1 Indirect tensile (IDT) strength testing.

2.3.2 Lottman AASHTO T283 Test with Five Freeze–Thaw Cycles

As previously explained, the Illinois modified AASHTO T283 test is a modified version of the Lottman AASHTO T283 test. In this study, the conditioned set of specimens was further conditioned for five FT cycles according to the following procedure:

1. The conditioned specimen air voids were saturated to a range of 70% to 80% under a vacuum of 10 to 26 in Hg partial pressure (13 to 67 kPa absolute pressure).
2. The saturated conditioned specimen was then wrapped in a plastic film and placed inside a plastic bag containing $0.61 \pm 0.031 \text{ in}^3$ ($10 \pm 0.5 \text{ mL}$) of water. The plastic bag was sealed and the specimen was placed in the freezer at a temperature of $0 \pm 5^\circ\text{F}$ ($-18 \pm 3^\circ\text{C}$) for at least 16 hr.
3. The specimen was removed from the freezer and the plastic film was immediately removed. The specimen was then placed in a $140 \pm 1.8^\circ\text{F}$ ($60 \pm 1^\circ\text{C}$) water bath for $24 \pm 1 \text{ hr}$.
4. Steps 2 and 3 represent one FT cycle. For three and five FT cycles, both steps were repeated three and five times, respectively.

5. At the end of the last FT cycle (third or fifth), the conditioned specimens were transferred to a $77 \pm 1.8^\circ\text{F}$ ($25 \pm 1^\circ\text{C}$) water bath for $2 \text{ hr} \pm 10 \text{ min}$.
6. The conditioned set of specimens was tested for IDT strength (Figure 2.1).

2.3.3 Wheel Tracking Test

To assess potential rutting, engineers in Germany developed the wheel tracking test more than two decades ago. The test is also used for evaluating the moisture susceptibility of hot-mix asphalt (HMA) related to aggregate structure, asphalt binder stiffness, or the adhesive bond between the aggregate and asphalt binder. The device tests two sets of two specimens simultaneously by moving steel wheels concurrently across the surface of the specimens, which are submerged in water at $122 \pm 2^\circ\text{F}$ ($50 \pm 1^\circ\text{C}$) (Izzo and Tahmooressi 1999). The specimen dimensions are 6 in (150 mm) diameter and 2.4 ± 0.1 in (62 ± 2 mm) height. The rut depth is measured at several points along the wheel path at a multiple number of wheel passes as well as at the end of the test. The threshold adopted for the test in this study was a maximum rut depth of 0.5 in (12.5 mm) at 10,000 passes for PG 64-22 and 15,000 passes for PG 70-22. Figure 2.2 shows the wheel tracking device.



Figure 2.2 Wheel tracking device.

2.3.4 Fracture Test (SCB Specimens)

The fracture resistance of HMA depends on asphalt binder type, aggregate type, asphalt content, asphalt binder modifier, and air voids (Li et al. 2010). Fracture potential is an indication of HMA ability to resist thermal cracking, which is a predominant type of failure in low-temperature regions. In this study, fracture potential was evaluated by testing SCB specimens for their fracture energy at 10.4°F (-12°C). Figure 2.3 shows a schematic of a typical SCB specimen and the test setup. Figure 2.4 shows the SCB specimen placed in the apparatus and ready for testing.

The SCB geometry can be easily prepared from both gyratory compacted samples and field cores. The primary result from testing SCB specimens is the load vs. deflection curve, seen

in Figure 2.5. The area under this curve is called the fracture work, W_f . Dividing the fracture work by the ligament area results in the fracture energy, Equation 2.2:

$$G_f = \frac{W_f}{A_{lig}} \quad (2.2)$$

where

- G_f = the fracture energy
- W_f = fracture work
- A_{lig} = ligament area ($A \times t$)
- A = ligament length
- t = sample thickness

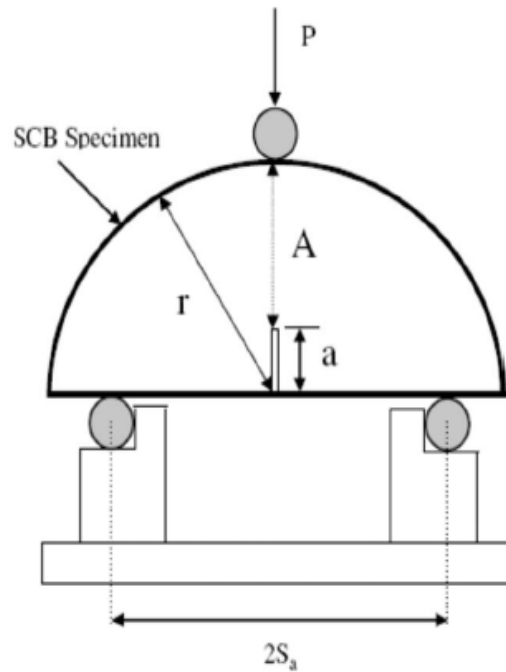

Figure 2.3 Typical SCB specimen with test setup.



Figure 2.4 SCB sample in testing apparatus.

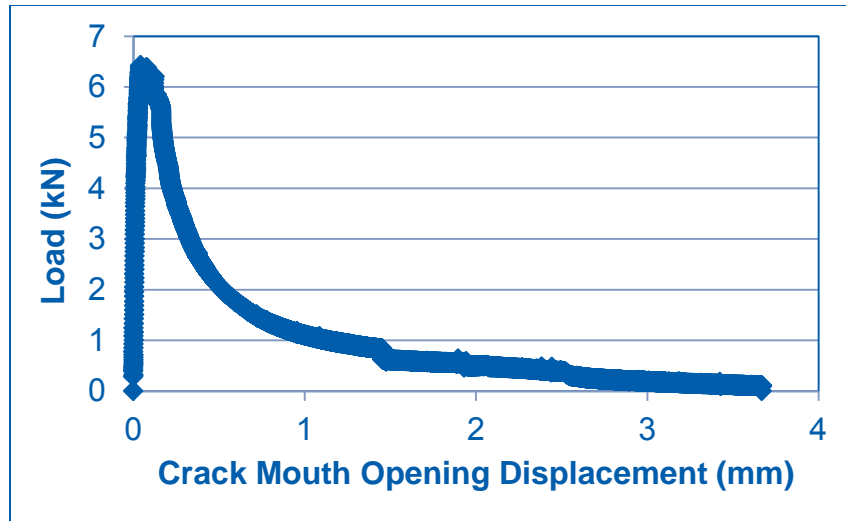

Figure 2.5 Typical result from SCB specimen fracture test.

2.4 TEST RESULTS AND DISCUSSION

Before initiating the laboratory tests, the mix designs for the N70 and N90 mixes were verified. Accordingly, buckets of aggregate were sampled from the stockpiles, dried, and sieved. Next, the gradation, bulk specific gravity, absorption, and loose and rodded unit weights were determined for each aggregate stockpile. The Bailey method was used to determine aggregate blend percentages and asphalt binder content necessary to achieve the required volumetrics. The design volumetrics for the N70 mix were 13.0% and 4.0% voids in the mineral aggregate (VMA) and air voids (AV), respectively, while for the N90 mix, the VMA and AV were 13.8% and 4.0%, respectively. After determining designs that provided the desired volumetrics within $\pm 0.1\%$, the next step was to optimize the asphalt binder contents. Table 2.2 shows the final aggregate blend percentages and asphalt binder contents, along with the volumetrics for both mixes.

Table 2.2 N70 and N90 Control Mix Designs

Control Mix	CM11 (%)	CM16 (%)	FM20 (%)	FM02 (%)	MF (%)	AC (%)	VMA (%)	AV (%)
N70	35.3	36.4	20.2	6.8	1.3	4.9	13.0	4.0
N90	38.7	38.2	21.8	—	1.3	5.2	13.8	4.0

In addition to the N70 control mix, four mixes were prepared using the four various additives and modifiers. The N70 mixes with LAS, SBS, and PPA had the same aggregate blend percentages and asphalt binder content as the N70 control mix. In the case of hydrated lime, the researchers had to minimally adjust aggregate and asphalt binder percentages in order to achieve the same volumetrics (VMA and AV) as the control mix. The same procedure was followed for N90.

The LAS, SBS, and PPA were added to asphalt binder. LAS was added in the lab, while SBS and PPA were added by the asphalt binder supplier. The amount of SBS and PPA added to the asphalt binder was sufficient to bump the PG from 64-22 to 70-22. The LAS contents used for the N70 and N90 mixes were 1.0% and 0.75%, respectively. These two values were based on the results from the modified Lottman AASHTO T283-02 test with five FT cycles on

specimens with various amounts of LAS (1.0%, 0.75%, 0.50%, and 0.25%). The hydrated lime was added to aggregate. The lime content adopted for the N70 and N90 mixes was 1.0%. The lime addition in this study was done through four techniques: marination, slurry, dry, and wet. Table 2.3 displays the details about the additional four N70 and N90 mixes.

Table 2.3 N70 and N90 Mix Designs with LAS, SBS, and PPA

Mix	Additive/Modifier	CM11	CM16	FM20	FM02	MF	AC (%)	PG
N70	Liquid Anti-Strip	35.3	36.4	20.2	6.8	1.3	4.9% w/1.0% liquid anti-strip	64-22
	SBS	35.3	36.4	20.2	6.8	1.3	4.9% SBS-modified asphalt binder	70-22
	PPA	35.3	36.4	20.2	6.8	1.3	4.9% PPA-modified asphalt binder	70-22
	Lime Marination / Slurry	34.94	36.03	20.0	6.73	1.3	4.85%, lime added to aggr.	64-22
	Lime, Dry / Wet	35.1	36.22	20.1	6.77	0.8	4.9%, lime added to aggr.	64-22
N90	Liquid Anti-Strip	38.7	38.2	21.8	—	1.3	5.2 w/0.75% liquid anti-strip	64-22
	SBS	38.7	38.2	21.8	—	1.3	5.2% SBS-modified asphalt binder	70-22
	PPA	38.7	38.2	21.8	—	1.3	5.2% PPA-modified asphalt binder	70-22
	Lime Marination / Slurry	38.31	37.81	21.6	—	1.3	5.15%, lime added to aggr.	64-22
	Lime Dry / Wet	38.5	38.0	21.7	—	0.8	5.2%, lime added to aggr.	64-22

2.4.1 Illinois Modified Lottman AASHTO T283-02 Test

This test was used primarily for checking the moisture susceptibility of the N70 and N90 mixes. Table 2.4 shows the results of this test.

Table 2.4 Moisture Susceptibility Evaluation of N70 and N90 Mixes, Conditioned with One Thaw Cycle

Mix	Set	Tensile Strength (psi)	TSR
N70	Unconditioned	74.8	84.0%
	Conditioned	62.8	
N90	Unconditioned	61.1	81.9%
	Conditioned	50.1	

The TSR values of the N70 and N90 mixes are 84.0% and 81.9%, respectively. Both the N70 and N90 mixes are considered to be moisture susceptible because the TSR values are less than 85.0%, which is the current threshold adopted by IDOT. In addition, the N90's conditioned tensile strength is less than 60 psi (410 kPa), the tensile strength threshold required by IDOT.

In addition to TSR, the post-TSR tested specimens were carefully observed, as shown in Figure 2.6. The strip rating for both mixes was obtained in accordance with IDOT's strip rating procedure. The strip ratings for both mixes were given a value of 3, which is the most severe strip rating.

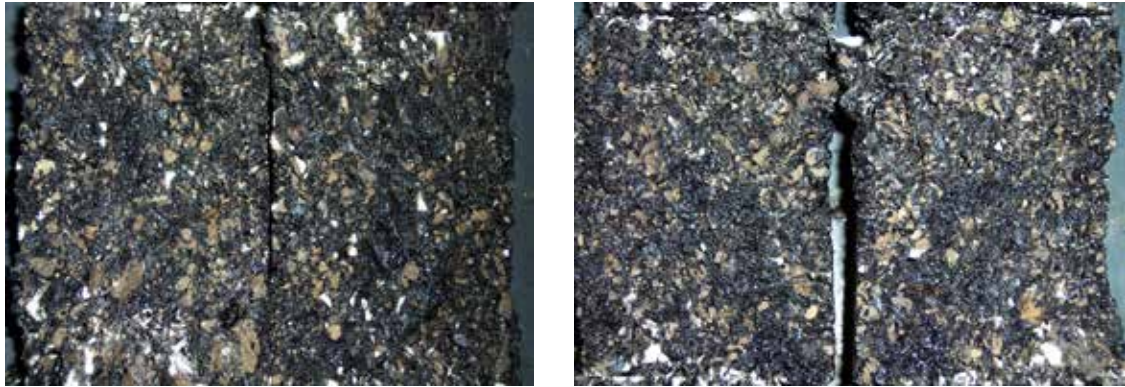

(a)

(b)

Figure 2.6 Samples from conditioned specimen set after testing from (a) N70 control mix, (b) N90 control mix.

2.4.2 Lottman AASHTO T283 Test with Five Freeze–Thaw Cycles

As a first step, an optimized LAS content was determined for both mixes. Tables 2.5 and 2.6 present the results of Lottman AASHTO T283 with five FT cycles on the N70 and N90 mixes with four LAS contents (0.25%, 0.50%, 0.75%, and 1.0%).

Table 2.5 N70 LAS Dosage Optimization

N70	LAS Content	TSR (%)	Unconditioned IDT Strength (psi)	Post 5 FT Cycles Conditioned IDT Strength (psi)
	1.00% LAS	88.2	54.0	47.6
0.75% LAS	81.6	51.8	42.2	
0.50% LAS	75.3	56.7	42.7	
0.25% LAS	82.3	56.3	46.3	
0.00% LAS	43.3	75.1	32.5	

Table 2.6 N90 LAS Dosage Optimization

N90	LAS Content	TSR (%)	Unconditioned IDT Strength (psi)	Post 5 FT Cycles Conditioned IDT Strength (psi)
	1.00% LAS	93	51.5	47.9
0.75% LAS	85.7	51.0	43.7	
0.50% LAS	74.4	57.7	42.9	
0.25% LAS	72.2	54.8	39.8	
0.00% LAS	45.2	61.1	27.6	

For the N70 mixes, 1.0% LAS was adopted because the TSR value passed the 85% threshold. Also, mixes with 1.0% LAS resulted in greater unconditioned and conditioned IDT

strengths compared with the mix with 0.75% LAS content. In the case of N90, the lowest LAS content to pass the 85% TSR threshold was 0.75%; 1% LAS also passed the TSR threshold, but did not produce a significant increase in unconditioned and conditioned IDT strength. a threshold of 0.75% was adopted to reduce costs.

The combined results of this test for all N70 and N90 asphalt lab mixes with and without additives and modifiers are shown in Tables 2.7 and 2.8 and in Figures 2.7 and 2.8.

Table 2.7 Modified Lottman AASHTO T283 Test Results for N70

N70	Additive/Modifier	TSR (%)	Unconditioned IDT Strength (psi)	Post 5 FT Cycles Conditioned IDT Strength (psi)
	Control	43.3	75.1	32.5
1.0% LAS	88.1	54.0	47.6	
PPA	39.7	69.3	27.5	
SBS	51.7	85.4	44.1	
Lime, Slurry (S)	83.9	56.0	47.0	
Lime, Marination (M)	85.3	58.7	50.1	
Lime, Dry (D)	69.5	63.6	44.2	
Lime, Wet (W)	70.0	68.9	48.2	

Table 2.8 Modified Lottman AASHTO T283 Test Results for N90

N90	Additive/Modifier	TSR (%)	Unconditioned IDT Strength (psi)	Post 5 FT Cycles Conditioned IDT Strength (psi)
	Control	45.2	61.1	27.6
0.75% LAS	85.7	51.0	43.7	
PPA	50.6	64.0	32.4	
SBS	57.3	78.8	45.2	
Lime, Slurry (S)	72.3	65.4	47.3	
Lime, Marination (M)	74.5	64.4	48.0	
Lime, Dry (D)	77.6	59.6	46.2	
Lime, Wet (W)	73.0	60.2	44.0	

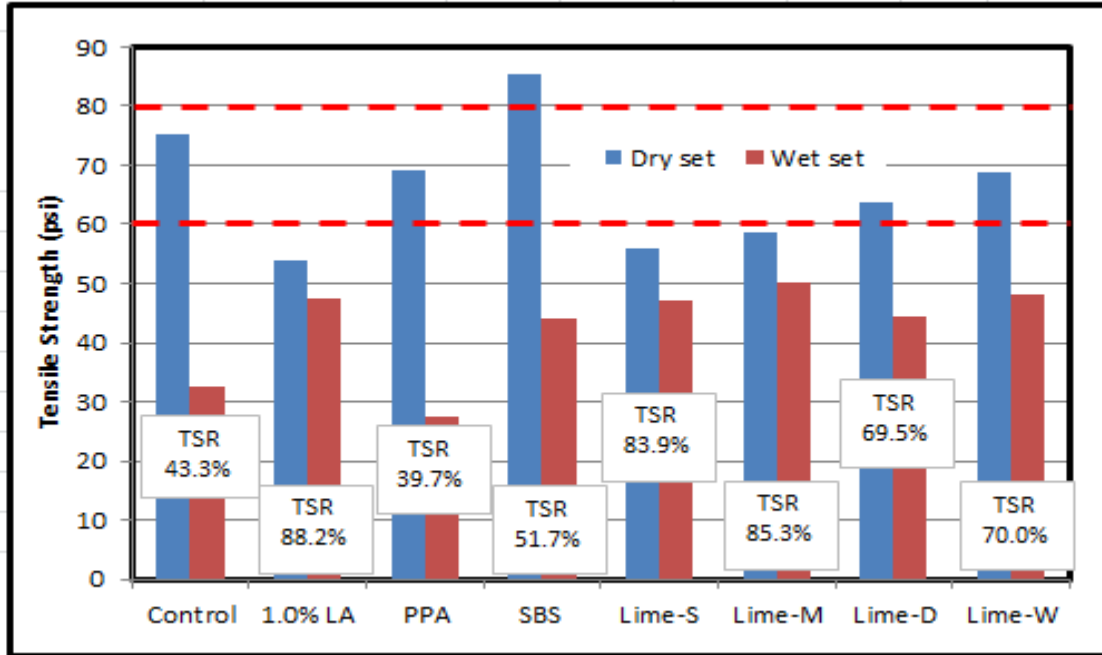

Figure 2.7 Modified Lottman AASHTO T283 test results for N70 after five freeze–thaw cycles.

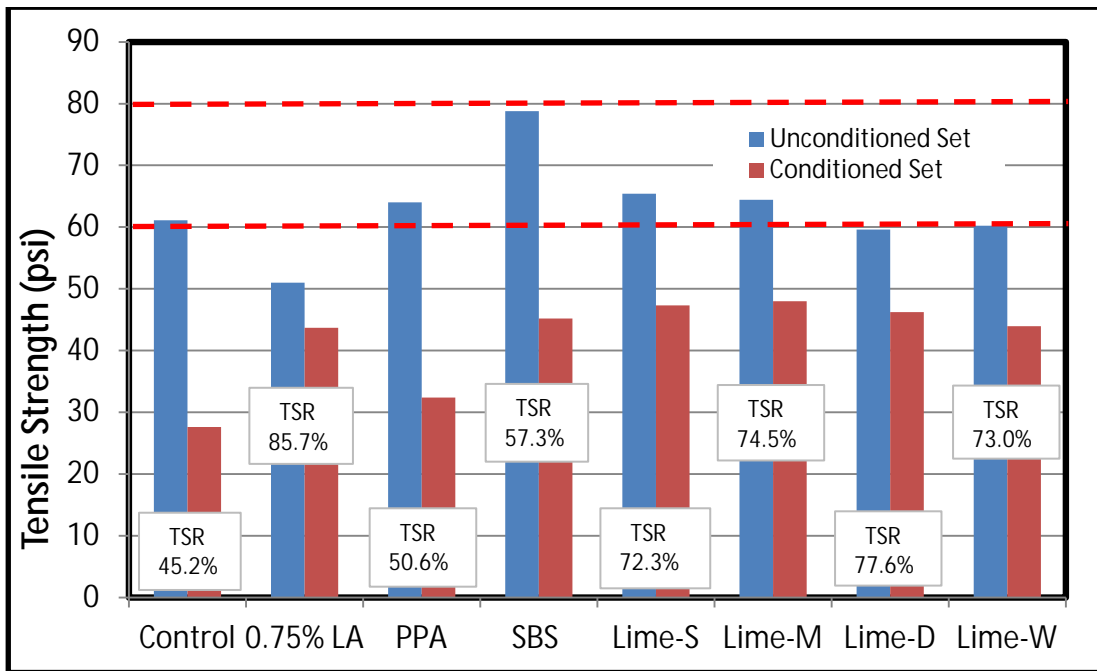

Figure 2.8 Modified Lottman AASHTO T283 test results for N90 after five freeze–thaw cycles.

The N70 PPA and N90 control mixes resulted in the lowest TSR values. With regard to only the additives and modifiers, it is clear that PPA had the lowest TSR. LAS had the highest TSR value, followed by hydrated lime. For N70, there was no significant difference between the TSR values of mixes with lime slurry or marination, or between mixes with lime added using the dry versus the wet method. For the N90 mixes, there was no significant difference in the performances of any of the mixes with lime added.

With regard to indirect tensile strength, N70 mix with SBS had greater than 80 psi (551.6 kPa), while the N70 control mix, N70 mix with hydrated lime dry, and N70 mix with hydrated lime wet were greater than 60 psi (413.7 kPa). For N90, the control mix, mix with hydrated lime slurry, and mix with hydrated lime marination were almost above 60 psi (413.7 kPa) for unmodified mixes. In general for N70 and N90, SBS provided the highest tensile strength for the unconditioned set. Asphalt concrete samples with hydrated lime had the highest tensile strength when the hydrated lime addition technique was used. Although mixes with hydrated lime and LAS did not result in a high unconditioned tensile strength, they were able to maintain relatively high conditioned tensile strength, even after five freezing and thawing cycles.

The most important conclusions that can be drawn from these TSR results are as follows:

- The addition of SBS resulted in increasing unconditioned tensile strength of the asphalt concrete; however, the modified mixture was greatly affected by moisture damage, ultimately resulting in a relatively low TSR value.
- LAS may increase conditioned (wet) adhesion, but it reduces unconditioned (dry) tensile strength, which yields artificially high TSR results. This could result in reducing service fatigue life.
- All methods of hydrated lime addition improved the dry and wet properties of the mix, with negligible effect on dry properties for N90 mixes and less severe reduction of dry properties than N70 mixes with LAS.
- The addition of PPA to a moisture-susceptible mix can escalate the moisture damage phenomenon; hence, using the appropriate LAS or hydrated lime along with PPA is recommended.

2.4.3 Wheel Tracking Test

The results of the wheel tracking test are presented in Figures 2.9 and 2.10. Recall that the thresholds for WTT are a maximum rut depth of 12.5 mm (0.5 in) at 10,000 passes for PG 64-22 and 15,000 passes for PG 70-22. With this in mind, all of the N70 and N90 mixes passed with the exception of mixes with PPA. Mixes with SBS and hydrated lime showed the least rutting potential compared with all other mixes. For mixes with hydrated lime, both the wet and marination techniques reduced the rutting potential for N70 and N90 mixes. In general, the mixes with LAS additive and PPA modifier exhibited greater rut depth potential than the control mix. Although PPA changed the asphalt binder grade from PG 64-22 to PG 70-22, compared with SBS, PPA increases the rutting potential of the mixes when tested by wheel tracking.

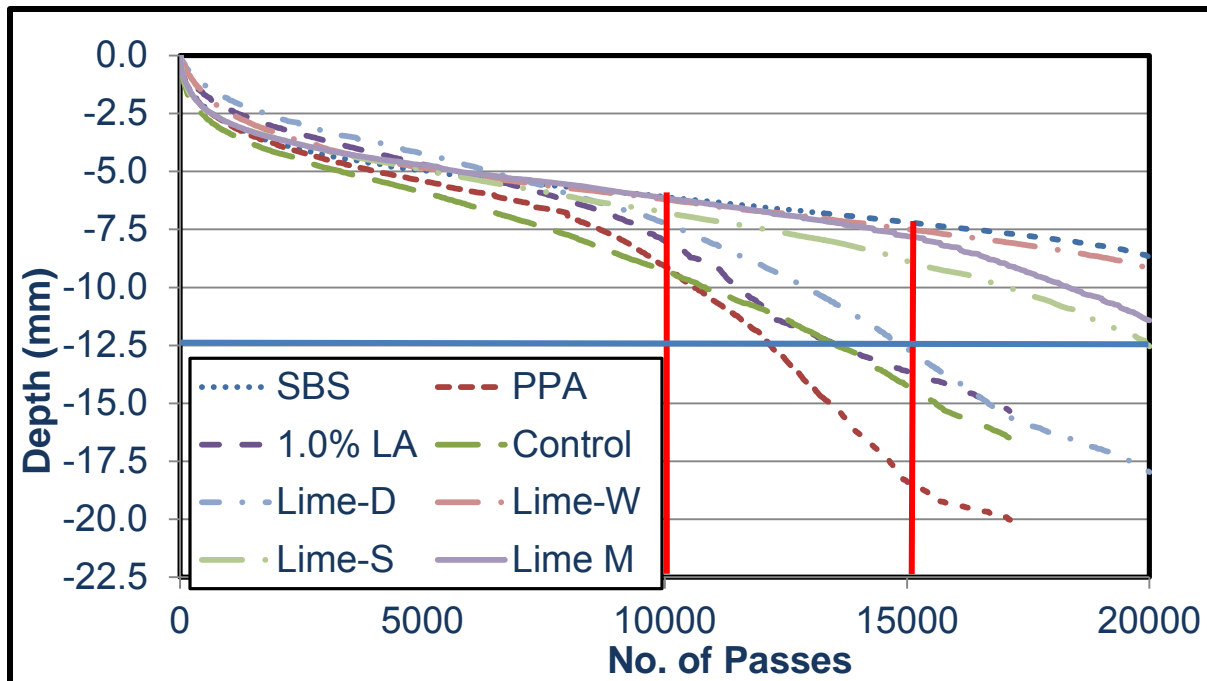

Figure 2.9 Wheel tracking test results for N70 mixes.

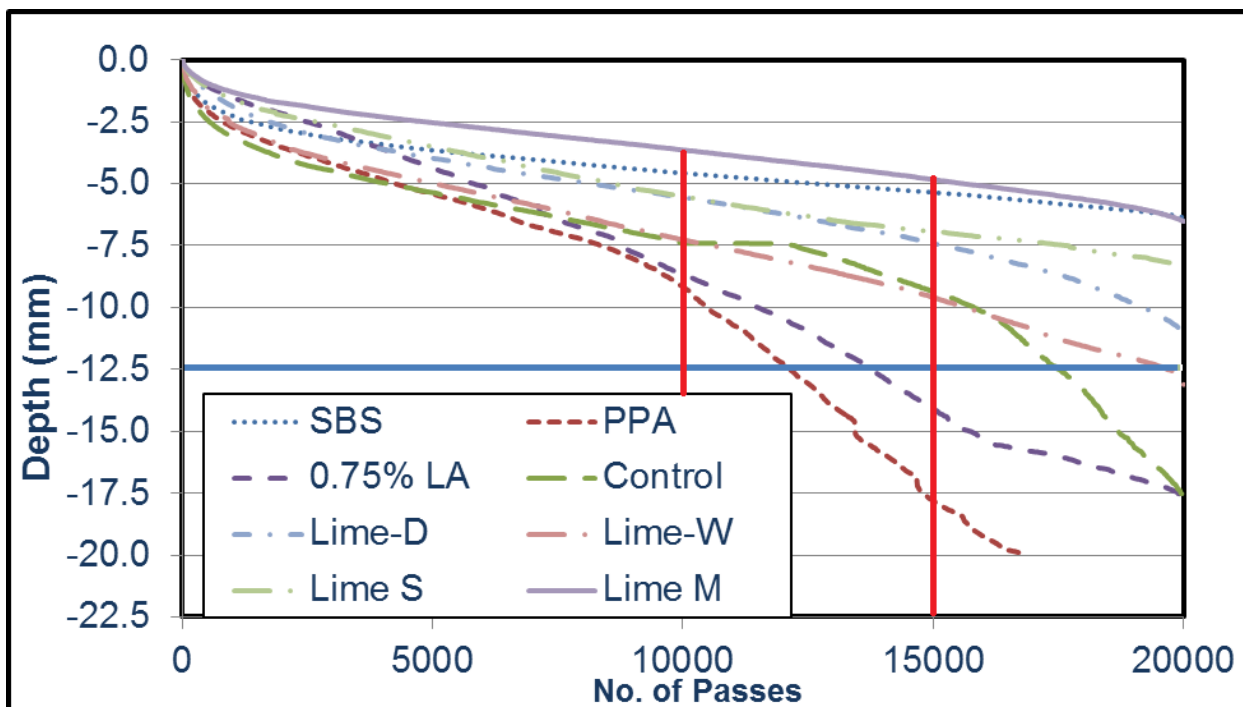

Figure 2.10 Wheel tracking test results for N90 mixes.

2.4.4 Fracture Test (SCB Specimens)

Figures 2.11 and 2.12 summarize the fracture results of the SCB tests for the N70 and N90 mixes, respectively. When LAS, SBS, hydrated lime marination, or hydrated lime wet are added to the N70 control mix, they significantly improved its fracture energy, with LAS resulting in the greatest fracture energy. An insignificant improvement with respect to the control mix occurred when PPA and hydrated lime slurry were added; mixes with PPA had the lowest fracture energy of the modified materials.

For the N90 mixes, adding hydrated lime by the marination process and hydrated lime wet resulted in the largest improvement in fracture energy, while other modifiers or additives reduced or had no effect on fracture energy compared with the control mix. The PPA modifier had the greatest reduction in fracture energy. For LAS, the reduction was negligible.

There is no assigned threshold for the SCB fracture test. However, extensive results, prior to this study, from running the SCB fracture test on various asphalt mixes at the Advanced Transportation Research Engineering Laboratory (ATREL) suggest that 41.2 ft-lbf/ft² (600 J/m²) is a reasonable threshold to identify the fracture susceptibility of mixes. However, it should be noted that although fracture is considered a fundamental property of materials, the results are dependent on the rate of loading of the test. Further investigation into loading rate effect is currently ongoing at ATREL and may offer a significant contribution to establishing a threshold. In summary, 41.2 ft-lbf/ft² (600 J/m²) is a qualitative rough baseline simply for the purpose of comparison.

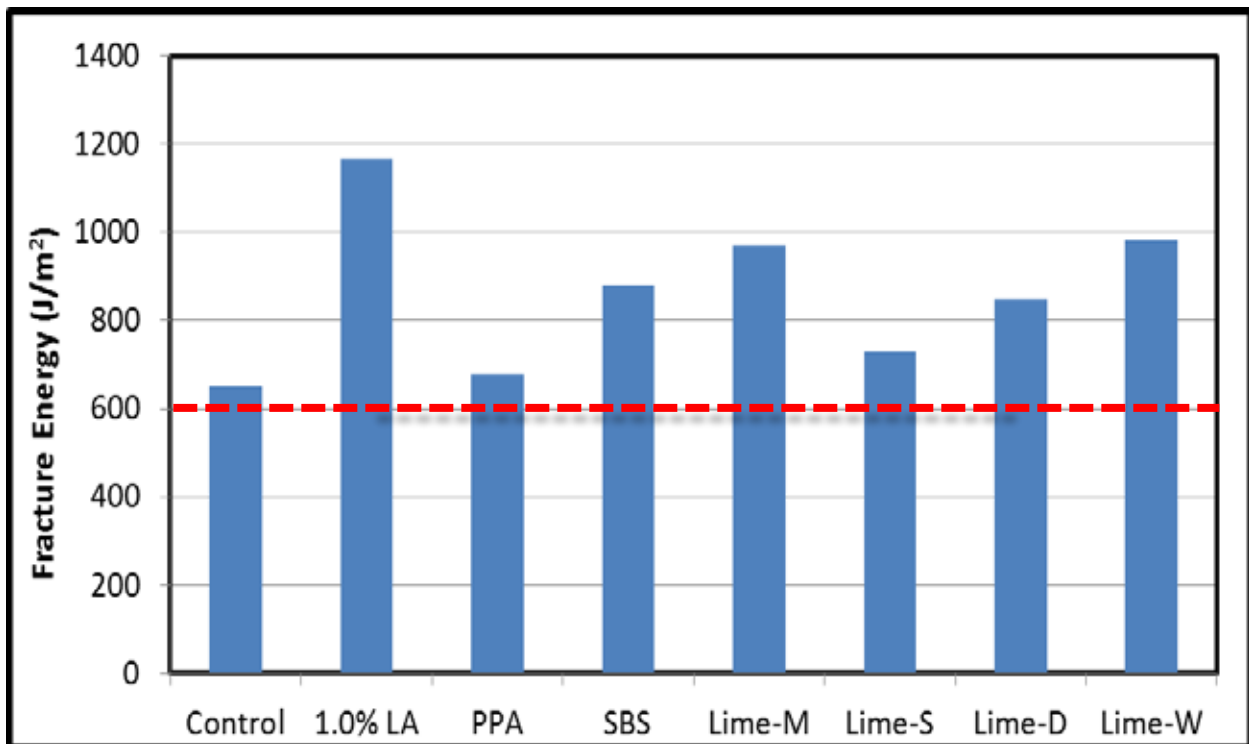

Figure 2.11 Fracture test results for N70.

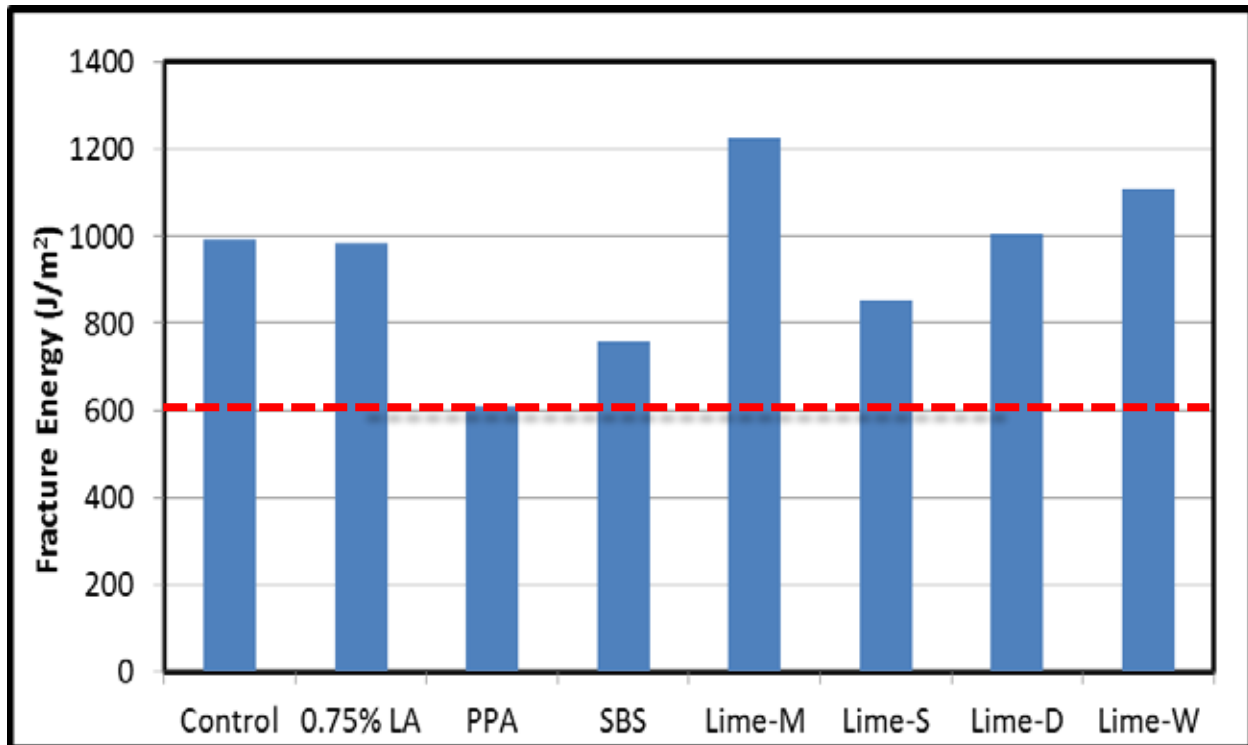

Figure 2.12 Fracture test results for N90.

2.5 SUMMARY, FINDINGS, AND RECOMMENDATIONS

Several additives and modifiers (LAS, SBS, PPA, and hydrated lime) were added to two typical Illinois asphalt mixes, an N70 and an N90. The moisture susceptibility of the mixes was evaluated using the Illinois modified AASHTO T283-02 test. In addition, the effect of the additives and modifiers was also evaluated by conducting the following tests: Lottman AASHTO T283-02 with five freezing and thawing cycles, wheel tracking, and fracture (SCB specimen). Both LAS and hydrated lime showed the ability to maintain the strength characteristics of mixes after severe environmental conditioning. The LAS reduced surface tension of asphalt binder and increased the asphalt binder wettability of aggregates, and hydrated lime decreased interfacial tension between asphalt binder and water. Such performance has also been evident in the reduced potential of thermal fracture. Although SBS reduced the rutting potential of the mixes at high service temperatures, the mixture stiffness dropped more rapidly than mixes with hydrated lime or LAS after the mixes were conditioned. Following are the detailed findings.

2.5.1 Findings

- Lottman AASHTO T283-02 test
 - 1.0% and 0.75% were found to be the optimum dosages of the LAS selected for the N70 and N90 mixes, respectively. These proportions were chosen as the lowest quantity to provide TSR values passing the 85% threshold and maintaining the required tensile strength of the asphalt mixtures.
 - Among all the tested additives and modifiers, mixes with PPA resulted in the lowest TSR values, while mixes with LAS resulted in the highest.

- The mixes with hydrated lime resulted in the second highest TSR values. For N70 mixes, there was insignificant negligible difference between the slurry and marination and between the dry and wet techniques. For N90 mixes, all hydrated lime treatment techniques appeared to have very similar effects on mixture performance.
- Generally, the additives and modifiers reduced the unconditioned tensile strength of mixes with the exception of SBS and hydrated lime. Mixes with SBS had the highest unconditioned tensile strength. This is in part due to the fact that the SBS had a greater high-temperature grade of PG-70 and therefore resulted in a stiffer material. Hydrated lime had little effect on unconditioned strength. On the other hand, mixes with hydrated lime had the highest conditioned tensile strength.
- Wheel tracking test
 - Compared with all other additives and modifiers, SBS and hydrated lime showed the best rutting resistance, while mixes with LAS reduced rutting resistance. PPA further reduced rutting resistance compared with the control mix and ultimately failed the wheel tracking test threshold.
 - Wet hydrated lime application or marination appears to most positively affect mixture rutting resistance, but all methods of hydrated lime addition enhanced rutting performance.
- Fracture test (SCB specimen)
 - Significant improvement in the fracture energy of the N70 control mix resulted when LAS, SBS, hydrated lime wet, and hydrated lime marination were used. The mix with LAS had the highest fracture energy, while the mix with PPA had the lowest fracture energy of the modified materials. Adding PPA or lime slurry to the N70 control mixes resulted in negligible improvement in fracture energy, but also did not show a negative impact.
 - For the N90 mixes, all of the tested additives and modifiers reduced fracture energy compared with the control mix, except for hydrated lime marination and hydrated lime wet mixes. The PPA modifier produced the greatest reduction in fracture energy, while LAS resulted in negligible change to fracture energy.

2.5.2 Recommendations

In light of these findings, the authors offer the following recommendations and comments:

- The selection of LAS should be optimized by type and dosage to improve conditioned tensile strengths while not reducing the unconditioned tensile strengths.
- LAS and hydrated lime appear to be effective additives/modifiers to control moisture damage.
- All forms of hydrated lime addition are effective in controlling moisture damage, with wet methods having an improved degree of control.
- For highly moisture-susceptible mixes, it is recommended to investigate SBS with LAS or SBS with hydrated lime to produce a mix that passes all the performance tests.

- Conduct more testing on mixes with the combination of PPA and hydrated lime or the combination of PPA and LAS to better understand PPA's contribution to the mix performance because, in several cases of this study, PPA showed a reduction in resistance to moisture damage compared with the control mix.

CHAPTER 3 ACCELERATED PAVEMENT TESTING

The results of several asphalt mixtures that were evaluated using an accelerated loading test device are reported and discussed in this chapter. These asphaltic mixtures utilized the same mix design as the N90 mixes discussed in Chapter 2. Two additional warm-mix asphalts (WMA) were evaluated: an N90 foamed mix and an N90 foamed mix with LAS. These asphaltic mixtures had the same aggregate gradation and asphalt binder content, but each had a different additive or modifier. The evaluation of the mixtures was based on rutting depth and visual stripping. The testing of the asphaltic mixtures was executed under both controlled moisture conditions and temperature.

3.1 PAVEMENT SECTIONS

The N90 mix was selected for the accelerated pavement testing (APT) part of this study. The selection of N90 was based on the availability of aggregate materials for the contractor. The N90 control mix, as discussed in Chapter 2, uses CM11, CM16, and FM20 aggregate stockpiles—all of which are dolomitic limestone (Table 3.1). The N90 mix is a 19.0 mm NMAS and is used as a binder course layer. The base asphalt used for this project is PG 64-22 with an optimum asphalt content of 5.2%.

Seven mixes were prepared based on the N90 control mix. Five of the seven mixes were the N90 control mix, an N90 control with LAS, an N90 control with hydrated lime (marination), an N90 control with SBS, and an N90 control with PPA. The mix design of each was already discussed in Chapter 2. The remaining two mixes were a warm-mix asphalt (WMA) produced using the foamed asphalt binder with and without LAS.

Prior to plant production, the aggregate blend percentages of the mixes had to be adjusted because of differences between lab and plant mix production operations. This adjustment was necessary to maintain the same volumetrics among the produced asphalt mixes. Eventually, all seven mixes were intended to have the same aggregate gradation and asphalt binder content except for the hydrated lime mix (Table 3.1). Chapter 2 contains a discussion of the N90 control mix with hydrated lime having different aggregate blend percentages and asphalt binder content.

The percentage of hydrated lime added to the aggregate at the plant was 1.3% (compared with 1.0% in the lab) by dry weight of the aggregate. The aggregate modified with hydrated lime was not mixed with asphalt binder until 24 hr of marination had taken place. The 5.2% asphalt binder content of the WMA was foamed with 1.0% moisture by weight of asphalt binder. LAS content for the foam mix was 0.75%.

Table 3.1 Aggregate Percentages for Asphaltic Mixtures

	CM11 (%)	CM16 (%)	FM20 (%)	AC (%)
Aggregate Percentages for Control and Foamed Mixes and Mixes with LAS, SBS, and PPA	40.4	41.1	18.5	5.2
Aggregate Percentages for Mixes with Hydrated Lime	40.33	41.04	18.62	5.12

3.2 APT FACILITY

Research was conducted at the Advanced Transportation Research and Engineering Laboratory (ATREL) in Rantoul, Illinois, using the **Accelerated Transportation Loading ASsembly (ATLAS)** device (Figure 3.1). ATLAS can apply a maximum moving load of 80 kips (356 kN). The system is capable of accommodating both truck tire and aircraft tire assemblies. The trafficable length under ATLAS (length that can be tested) is 85 ft (25.9 m) at a speed of up to 10 mph (16 kph).



Figure 3.1 Accelerated Transportation Loading Assembly (ATLAS).

3.3 CONSTRUCTION SITE

The seven mixes were produced and paved by Open Road Paving Company. Each of the seven mixes was paved in a section 71 ft (21.6 m) long with a thickness of 2.25 in (5.7 cm) on a continuously reinforced concrete section that was milled, cleaned, and tacked prior to placement of the overlay.

Figure 3.2 depicts a typical testing section. The mixes were arranged as displayed in Figure 3.3, which shows the four testing positions for ATLAS; in each position, ATLAS is able to test a pair of sections. Figure 3.4 shows site construction details and sequence, including milling, cleaning, HMA placement, and thickness measurements using ground penetrating radar (GPR) and nuclear gauges.

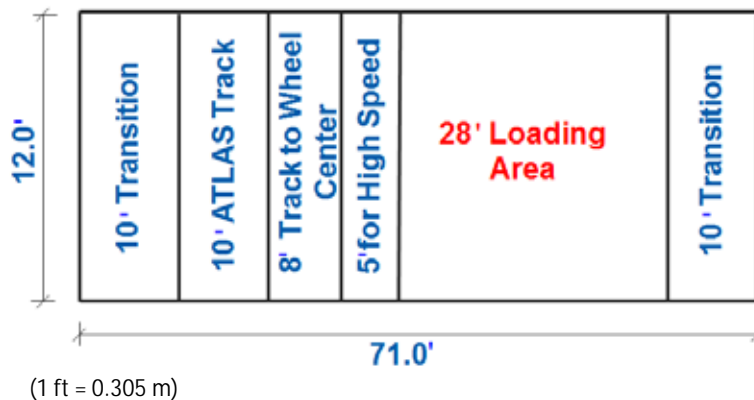

Figure 3.2 Typical testing section.

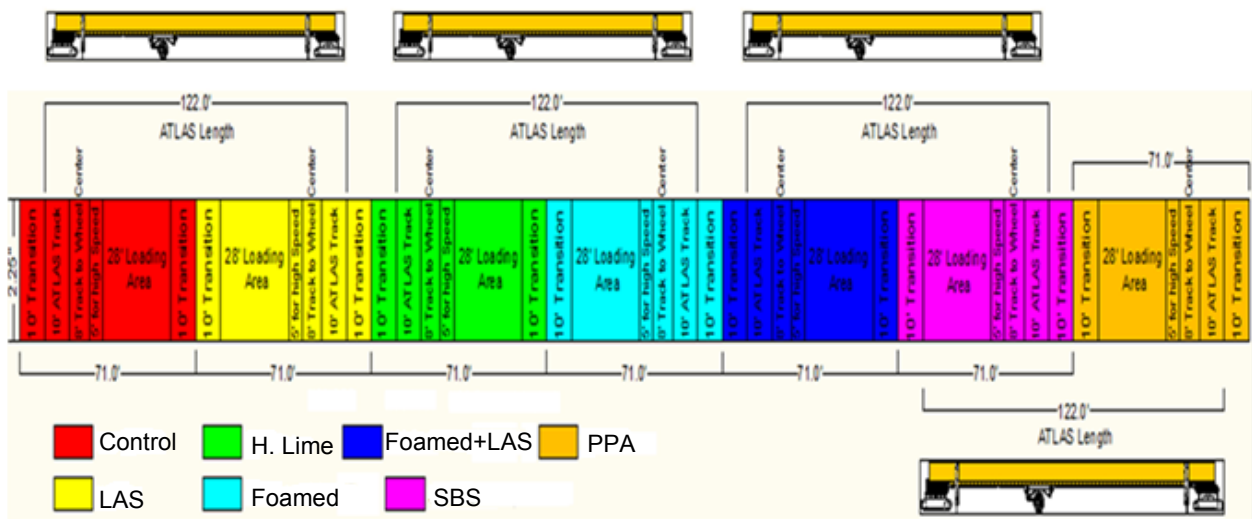

Figure 3.3 Construction layout.



(a) Milling



(b) Cleaning



(c) Applying tack coat



(d) Paving

Figure 3.4 Site construction stages (continues, next page).



(e) Compaction



(f) Density measurement using GPR



(g) Density measurement using nuclear gauge

Figure 3.4 Site construction stages (continued from previous page).

3.4 TESTING DESCRIPTION

The tire assembly used in this project was a dual tire with 110 psi (758.4 kPa) tire pressure applied at 8 mph (12.9 kph) speed. The minimum number of cycles applied on each testing position was 60,000. The tire load applied was 10 kips (44 kN) for the first 30,000 cycles and then increased to 14 kips (62 kN) for the remaining 30,000 cycles. If additional cycles were required beyond 60,000 cycles, the tire load was increased to 18 kips (80 kN).

The sections were tested under hot, wet conditions. The pavement temperature while load tested was maintained at 90°F (32°C) at 2 in (5 cm) below the surface, using a thermocouple connected to the environmental system. Keeping the temperature constant was achieved by using insulated side panels affixed to ATLAS (Figures 3.5 and 3.6).



Figure 3.15 In addition to the side panels, heaters were placed around the pavement (Figure 3.6). The main parameters of interest were rutting depth and visual stripping.



Figure 3.6 Heaters and shields under ATLAS.

3.5 APT RESULTS

Twenty bags were sampled for each of the seven mixes from the plant during production. The bags were preheated in the lab and split to prepare samples for maximum theoretical specific gravity (G_{mm}), extraction, modified Lottman AASHTO T283, WTT, and SCB fracture tests. Extraction was conducted at ATREL and at IDOT's Bureau of Materials and Physical Research (BMPR). Disparities between extraction test results and mix design were observed, which promoted further investigations.

Table 3.2 shows G_{mm} values measured at Open Road Pavement (ORP) and ATREL laboratories. As is apparent from Table 3.2, G_{mm} values measured at ATREL are higher than the values reported by ORP's lab, which in turn means the paved sections have lower calculated (in situ) densities if using ATREL values. At the time of construction, the research team encountered an uncertainty in reporting G_{mm} values between the plant and field.

Table 3.2 G_{mm} Values Measured at ORP and ATREL Laboratories

Mix	ORP G_{mm}	ATREL G_{mm}
Coarse-Graded Binder (Control)	2.482	2.497
Coarse-Graded Binder (LAS)	2.475	2.502
Coarse-Graded Binder (Hydrated Lime)	2.500	2.515
Coarse-Graded Binder (Foamed)	2.487	2.508
Coarse-Graded Binder (Foamed + LAS)	2.472	2.468
Coarse-Graded Binder (SBS)	2.443	2.496
Coarse-Graded Binder (PPA)	2.486	2.503

A detailed discussion by the research team and TRP members regarding the counterintuitive trends resulted in further investigation into this discrepancy. It was agreed to conduct extraction tests at BMPR on field cores near and at the wheel path.

3.5.1 Extraction of Field Cores

To further investigate the field mix designs, cores were obtained from APT sections. Figures 3.7 and 3.8 display the layout of cores taken both near and at the wheel path. Tables 3.3 through 3.7 show the extraction results for cores obtained near the wheel path from the control section and the sections of mixes with LAS, PPA, SBS, and hydrated lime. Tables 3.8 through 3.12 on the other hand, show the extraction results for the same mixes from cores extracted at the wheel path.

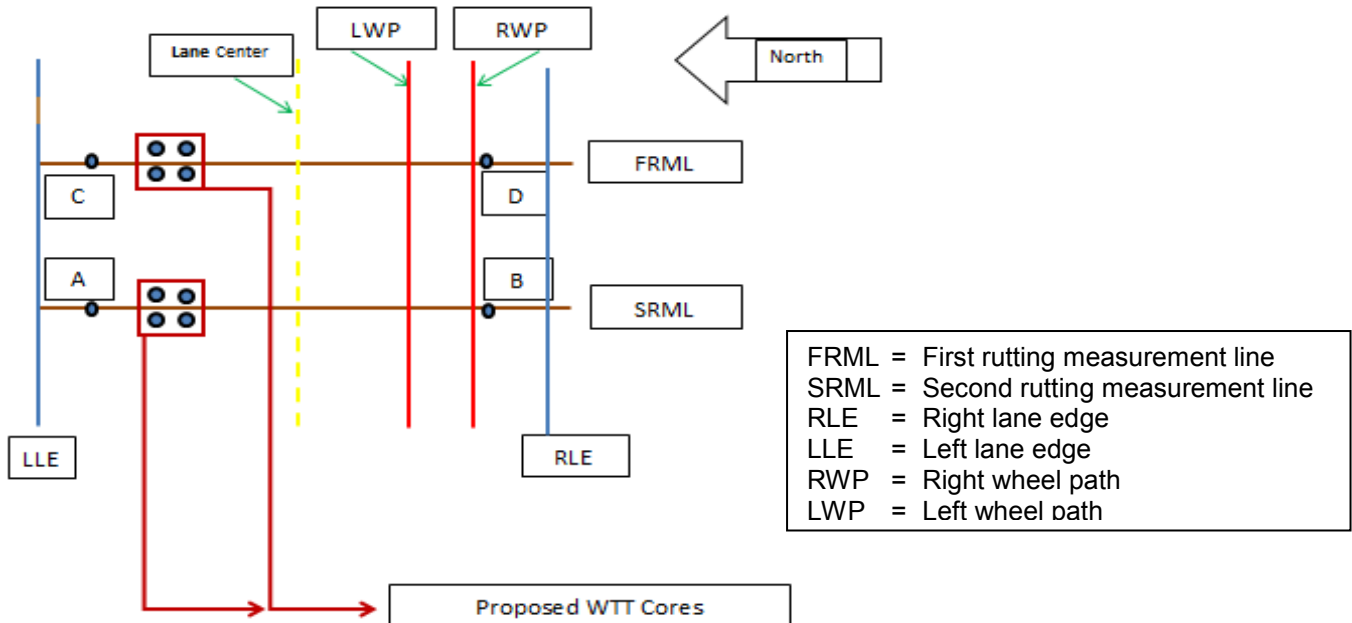

Figure 3.7 Layout for cores near wheel path.

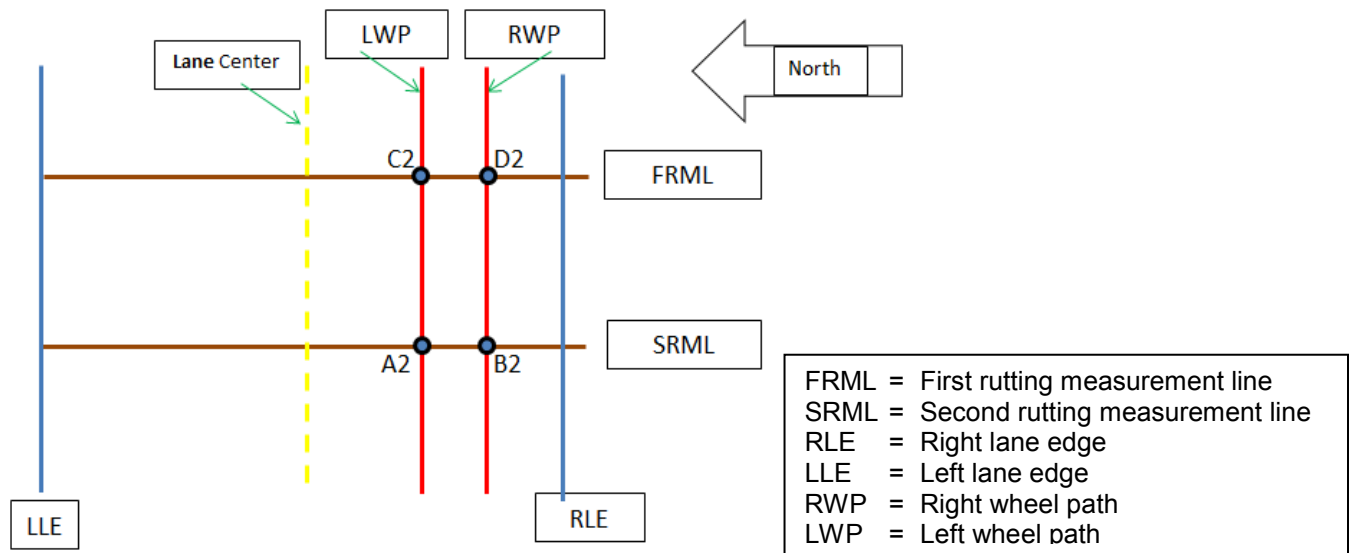

Figure 3.8 Layout for cores at wheel path.

Table 3.3 Extraction of N90 Control Cores Near Wheel Path

Cores	Avg. ABCD	Design	Avg. vs. Design	Range
Sieves	% Passing			
37.5 / 1.5	100	100	0	100
25 / 1	100	100	0	100
19 / 3/4	94	93	+1	92–97 (5)
12.5 / 1/2	76	77	-1	73–78 (5)
9.5 / 3/8	68	68	0	65–69 (4)
4.75 / #4	41	39	+2	39–42 (3)
2.36 / #8	24	22	+2	23–24 (1)
1.18 / #16	14	14	0	14
0.60 / #30	10	9	+1	9–10 (1)
0.30 / #50	7	7	0	7
0.15 / #100	6	6	0	6
0.75 / #200	5.6	4.9	+0.7	5.4–5.7 (0.3)
% AC	5.3	5.2	+0.1	5.2–5.4 (0.2)

Table 3.4 Extraction of N90 with LAS Cores Near Wheel Path

Cores	Avg. ABCD	Design	Avg. vs. Design	Range
Sieves	% Passing			
37.5 / 1.5	100	100	0	100
25 / 1	100	100	0	100
19 / 3/4	94	93	+1	93–95 (2)
12.5 / 1/2	77	77	0	74–78 (4)
9.5 / 3/8	68	68	0	66–70 (4)
4.75 / #4	42	39	+3	40–44 (4)
2.36 / #8	24	22	+2	23–25 (2)
1.18 / #16	14	14	0	13–15 (2)
0.60 / #30	10	9	+1	9–10 (1)
0.30 / #50	8	7	+1	7–8 (1)
0.15 / #100	7	6	+1	6–7 (1)
0.75 / #200	5.7	4.9	+0.8	5.5–5.9 (0.4)
% AC	5.4	5.2	+0.2	5.1–5.6 (0.5)

Table 3.5 Extraction of N90 with PPA Cores Near Wheel Path

Cores	Avg. ABCD	Design	Difference	Range
Sieves	% Passing			
37.5 / 1.5	100	100	0	100
25 / 1	100	100	0	100
19 / 3/4	96	93	+3	94–97 (3)
12.5 / 1/2	82	77	+5	77–86 (9)
9.5 / 3/8	74	68	+6	67–79 (12)
4.75 / #4	45	39	+6	40–51 (11)
2.36 / #8	27	22	+5	24–31 (7)
1.18 / #16	18	14	+4	16–20 (4)
0.60 / #30	12	9	+3	12–14 (2)
0.30 / #50	10	7	+3	10–11 (1)
0.15 / #100	10	6	+4	9–11 (2)
0.75 / #200	8.7	4.9	+3.8	8.0–9.5 (1.5)
% AC	5.4	5.2	+0.2	4.9–6.2 (1.3)

Table 3.6 Extraction of N90 with SBS Cores Near Wheel Path

Cores	Avg. ABCD	Design	Difference	Range
Sieves	% Passing			
37.5 / 1.5	100	100	0	100
25 / 1	100	100	0	100
19 / 3/4	94	93	+1	94–95 (1)
12.5 / 1/2	76	77	-1	76–78 (2)
9.5 / 3/8	67	68	-1	66–69 (3)
4.75 / #4	41	39	+2	40–42 (2)
2.36 / #8	26	22	+4	25–26 (1)
1.18 / #16	17	14	+3	16–17 (1)
0.60 / #30	12	9	+3	11–12 (1)
0.30 / #50	10	7	+3	9–10 (1)
0.15 / #100	9	6	+3	8–9 (1)
0.75 / #200	7.8	4.9	+2.9	7.4–8.0 (0.6)
% AC	5.3	5.2	+0.1	5.2–5.4 (0.2)

Table 3.7 Extraction of N90 with Hydrated Lime Cores Near Wheel Path

Cores	Avg. ABCD	Design	Difference	Range
Sieves	% Passing			
37.5 / 1.5	100	100	0	100
25 / 1	100	100	0	100
19 / 3/4	96	93	+3	93–98 (5)
12.5 / 1/2	82	77	+5	76–88 (12)
9.5 / 3/8	78	68	+10	68–80 (12)
4.75 / #4	45	39	+6	41–51 (10)
2.36 / #8	26	22	+4	23–29 (6)
1.18 / #16	15	14	+1	13–17 (4)
0.60 / #30	11	9	+2	9–11 (2)
0.30 / #50	9	7	+2	8–10 (2)
0.15 / #100	8	6	+2	7–9 (2)
0.75 / #200	7.0	4.9	+2.1	6.2–7.7 (1.5)
% AC	5.6	5.2	+0.4	5.3–6.1 (0/8)

Extraction results presented in Tables 3.3 through 3.7 clearly show that the field mix designs differ from lab mix designs (Figure 3.9). However, the N90 control and N90 with LAS appear relatively similar to the lab mix design, as well as to the N90 with SBS. Hence, results of these three field mixes were used for further analysis.



Figure 3.9 Several field sections showing possible mix uniformity issues.

Table 3.8 Extraction of N90 Control Cores at Wheel Path

Cores	Avg. ABCD	Design	Avg. vs. Design	Range
Sieves	% Passing			
3.5 / 1.5	100	100	0	100
25 / 1	100	100	0	100
19 / 3/4	95	93	+2	92–97 (5)
12.5 / 1/2	81	77	+4	73–78 (5)
9.5 / 3/8	72	68	+4	65–69 (4)
4.75 / #4	44	39	+5	39–42 (3)
2.36 / #8	26	22	+4	23–24 (1)
1.18 / #16	15	14	+1	14
0.60 / #30	10	9	+1	9–10 (1)
0.30 / #50	8	7	+1	7
0.15 / #100	7	6	+1	6
0.75 / #200	6.0	4.9	+1.1	5.4–5.7 (0.3)
% AC	5.8	5.2	+0.6	5.2–5.4 (0.2)

Table 3.9 Extraction of N90 with LAS Cores at Wheel Path

Cores	Avg. ABCD	Design	Avg. vs. Design	Range
Sieves	% Passing			
37.5 / 1.5	100	100	0	100
25 / 1	100	100	0	100
19 / 3/4	95	93	+2	93–95 (2)
12.5 / 1/2	80	77	+3	74–78 (4)
9.5 / 3/8	70	68	+2	66–70 (4)
4.75 / #4	44	39	+5	40–44 (4)
2.36 / #8	25	22	+3	23–25 (2)
1.18 / #16	15	14	+1	13–15 (2)
0.60 / #30	10	9	+1	9–10 (1)
0.30 / #50	8	7	+1	7–8 (1)
0.15 / #100	7	6	+1	6–7 (1)
0.75 / #200	6.0	4.9	+1.1	5.5–5.9 (0.4)
% AC	5.7	5.2	+0.5	5.1–5.6 (0.5)

Table 3.10 Extraction of N90 with PPA Cores at Wheel Path

Cores	Avg. ABCD	Design	Difference	Range
Sieves	% Passing			
37.5 / 1.5	100	100	0	100
25 / 1	100	100	0	100
19 / 3/4	97	93	+4	94–97 (3)
12.5 / 1/2	83	77	+6	77–86 (9)
9.5 / 3/8	74	68	+6	67–79 (12)
4.75 / #4	44	39	+5	40–51 (11)
2.36 / #8	27	22	+5	24–31 (7)
1.18 / #16	18	14	+4	16–20 (4)
0.60 / #30	13	9	+4	12–14 (2)
0.30 / #50	11	7	+4	10–11 (1)
0.15 / #100	10	6	+4	9–11 (2)
0.75 / #200	8.7	4.9	+3.8	8.0–9.5 (1.5)
% AC	5.4	5.2	+0.2	4.9–6.2 (1.3)

Table 3.11 Extraction of N90 with SBS Cores at Wheel Path

Cores	Avg. ABCD	Design	Difference	Range
	% Passing			
37.5 / 1.5	100	100	0	100
25 / 1	100	100	0	100
19 / 3/4	96	93	+3	94–95 (1)
12.5 / 1/2	80	77	+3	76–78 (2)
9.5 / 3/8	70	68	+2	66–69 (3)
4.75 / #4	42	39	+3	40–42 (2)
2.36 / #8	27	22	+5	25–26 (1)
1.18 / #16	17	14	+3	16–17 (1)
0.60 / #30	12	9	+3	11–12 (1)
0.30 / #50	10	7	+3	9–10 (1)
0.15 / #100	9	6	+3	8–9 (1)
0.75 / #200	8.0	4.9	+3.1	7.4–8.0 (0.6)
% AC	5.5	5.2	+0.3	5.2–5.4 (0.2)

Table 3.12 Extraction of N90 with Hydrated Lime Cores at Wheel Path

Cores	Avg. ABCD	Design	Difference	Range
	% Passing			
Sieves				
37.5 / 1.5	100	100	0	100
25 / 1	100	100	0	100
19 / 3/4	97	93	+4	93–98 (5)
12.5 / 1/2	85	77	+8	76–88 (12)
9.5 / 3/8	76	68	+8	68–80 (12)
4.75 / #4	47	39	+8	41–51 (10)
2.36 / #8	27	22	+5	23–29 (6)
1.18 / #16	16	14	+2	13–17 (4)
0.60 / #30	11	9	+2	9–11 (2)
0.30 / #50	9	7	+2	8–10 (2)
0.15 / #100	8	6	+2	7–9 (2)
0.75 / #200	7.0	4.9	+2.1	6.2–7.7 (1.5)
% AC	5.7	5.2	+0.5	5.3–6.1 (0.8)

Extraction results presented in Tables 3.8 through 3.12 confirm the findings of the first extraction set, once again indicating that several mixes vary significantly from design, with the

exception of the N90 control, N90 with LAS, and N90 with SBS, which again are relatively similar to the lab mix design. Hence, these three plant mixes will be discussed in this section because they most closely matched design specifications and laboratory mixes.

3.5.2 APT Section Rutting Measurements

As previously mentioned, seven sections were constructed, but only three mixes were found to be close to the lab mix design. These mixes were the N90 control, N90 with LAS, and N90 with SBS. Each section was tested for a different number of cycles; progress was monitored at set intervals. Table 3.13 shows the total number of cycles applied on each section, and Figure 3.10 shows the rutting measurements for each section.

Table 3.13 Number of Cycles Applied by ATLAS for Each Section

Section	No. of Cycles
Coarse-Graded Binder (SBS)	60,000
Coarse-Graded Binder (LAS)	120,000
Coarse-Graded Binder (Control)	120,000

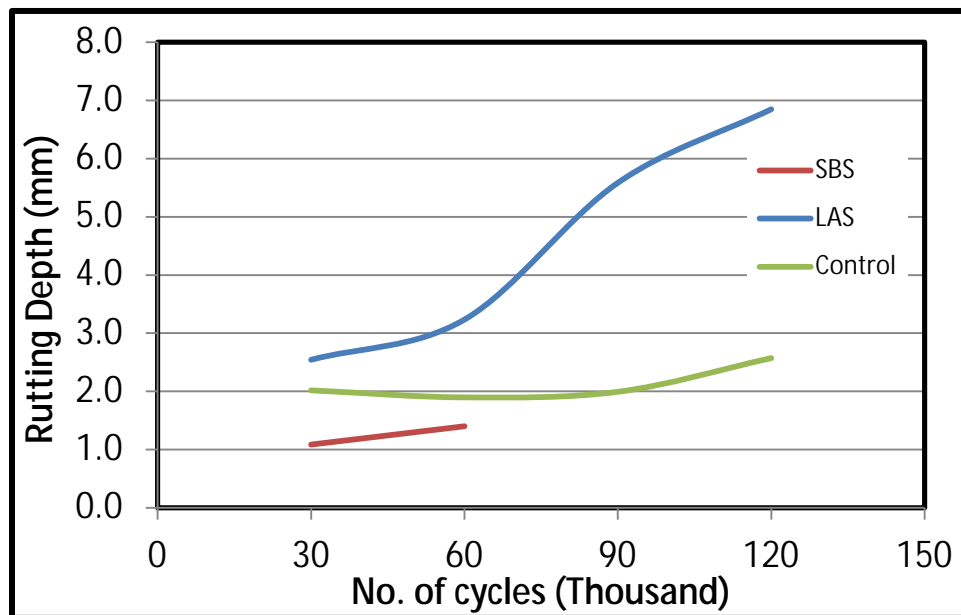

Figure 3.10 Rutting measurements for each section.

The major findings from ATLAS testing show that there was no significant rutting in any of the tested sections, although the mix with LAS showed more rutting than other sections, while the mix with SBS showed lower rutting. As previously shown in Figure 2.10, the rutting results from ATLAS correlate with the outcomes of WTT conducted on N90 SBS, N90 LAS, and N90 control lab mixes as presented in Chapter 2. In both outcomes, N90 SBS had reduced rutting potential compared with the control mix, while LAS increased that potential. In addition to

ATLAS testing, further laboratory tests were conducted on field loose mixes and are discussed in the following section.

3.5.3 Lab Testing on Field Loose Mix Samples

In this section, results from three laboratory tests conducted on the control, with SBS, and with LAS field loose mixes will be discussed. Laboratory tests conducted were the modified Lottman AASHTO T283 test, WTT, and fracture test using SCB specimens. Table 3.14 and Figure 3.11 show results from the modified Lottman AASHTO T283 test. Figures 3.12 and 3.13 show WTT test and SCB fracture test results, respectively.

Table 3.14 Modified Lottman AASHTO T283 Test Results from Sampled Field Bags

N90	Additive/Modifier	TSR (%)	Unconditioned Tensile Strength (psi)	Conditioned Tensile Strength (psi)
	Control	69.7	134.8	93.9
	0.75% LAS	74.0	107.3	79.4
	SBS	81.7	104.4	85.3

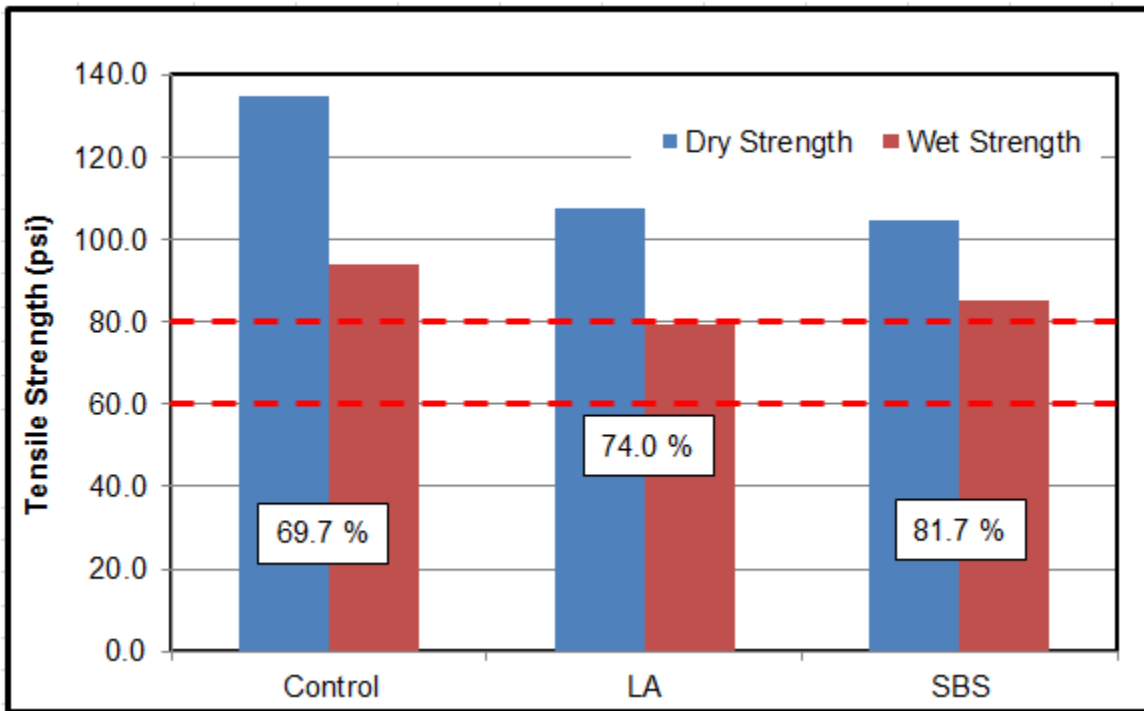

Figure 3.11 Modified Lottman AASHTO T283 test results on specimens from field bags.

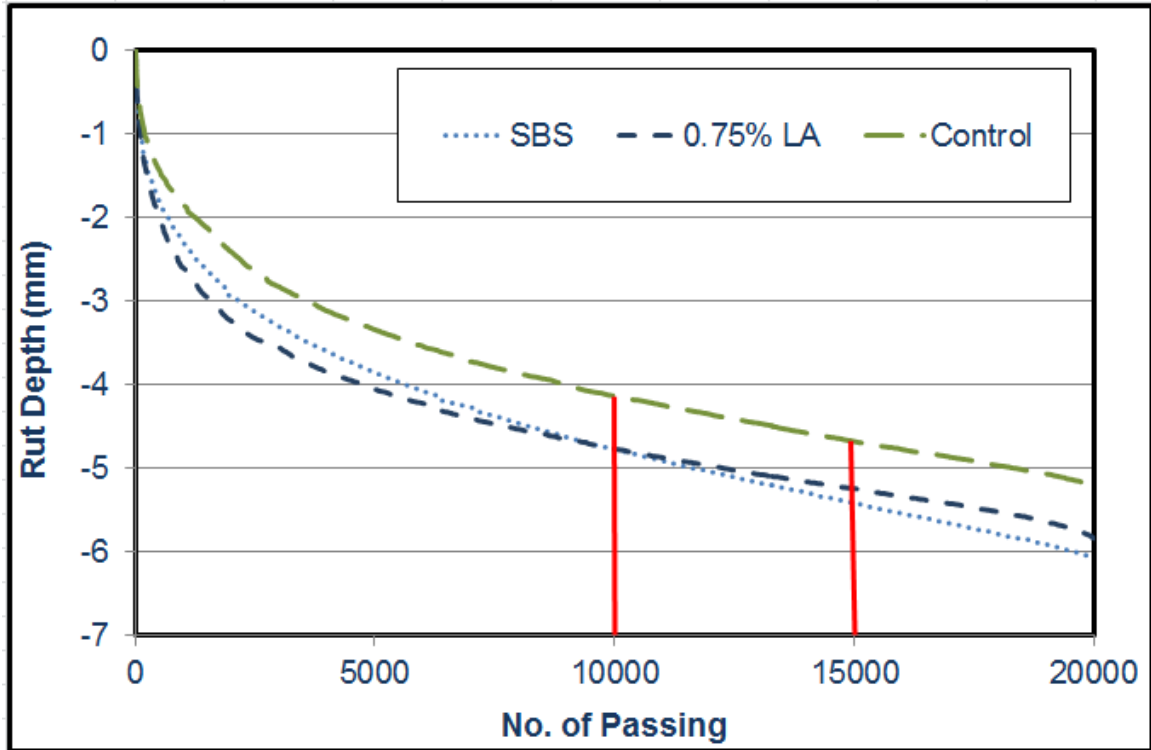

Figure 3.12 WTT results of specimens prepared from sampled field bags.

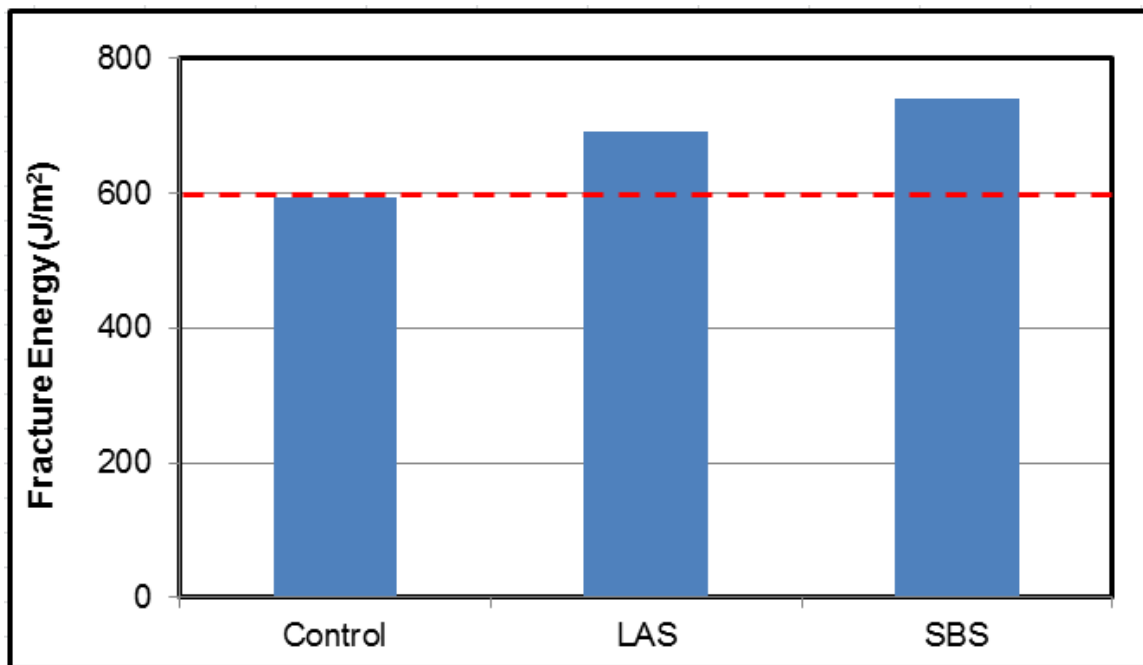

Figure 3.13 SCB fracture test results on specimens prepared from field loose mix.

By comparing the results displayed in Figures 3.10 through 3.12 with results from Chapter 2 for lab mixes, the following observations may be made:

1. LAS had almost the same trend when added to N90 control field and lab mixes. This statement is true for all three tests.
2. On the other hand, field mixes with SBS did not result in the same performance as recorded for the lab mixes, which could be due to high fine content in N90 with SBS field mix.

3.6 SUMMARY

Seven mixes were used to construct pavement sections for accelerated loading testing. However, results of field core extraction showed a significant difference between some of the field and lab mix designs, while other mixes—the N90 control, N90 with LAS, and N90 with SBS—were similar. Those three mixes were tested using ATLAS. Load repetitions ranged from 60,000 to 120,000 cycles. Lab testing conducted on plant mix specimens prepared from loose mix collected during production indicated that results for the control mix and mix with LAS correlate well with lab testing results conducted on lab-prepared mixes.

CHAPTER 4 COMPONENT-LEVEL TESTING

Four types of asphalt binder, as well as dolomitic limestone aggregate, were evaluated by means of two component-level tests. The four asphalt binders shared the same neat asphalt binder, PG 64-22 (control binder). The four asphalt binders were the control, control with liquid anti-strip (LAS), control with polyphosphoric acid (PPA), and control with styrene butadiene styrene (SBS). The two component-level tests were the surface free energy (SFE) test and direct adhesion test (DAT).

Asphalt binders were first tested using a dynamic shear rheometer (DSR) to determine the high-temperature performance grade and to measure the asphalt binder complex shear modulus (G^*). These asphalt binders were then tested using the sessile drop testing device for their component and total SFE. Likewise, using the same sessile drop device, the dolomitic limestone aggregate was tested for its SFE parameters. In addition, asphalt binders were tested using the DAT.

The SFE test was also used to check the effect of heat stability of asphalt binder with LAS. Hence, SFE was measured for the control asphalt binder with LAS after one month and two months of storage.

4.1 MATERIAL CHARACTERISTICS

The effect of LAS additive and the two modifiers, PPA and SBS, on asphalt binder was investigated. Descriptions and characteristics of LAS, PPA, and SBS were provided in Chapter 2. The dolomitic limestone aggregate was imported from the same quarry as the CM11, CM16, and FM20 aggregate stockpiles used in the asphalt mixes (N70 and N90), as discussed in Chapter 2.

4.2 COMPONENT-LEVEL TESTS

4.2.1 Surface Free Energy (SFE) Test

Failure of a bituminous mix caused by moisture can be attributed to adhesive and/or cohesive damage within the mix. Adhesion between aggregate and asphalt binder can be described mainly as a fundamental characteristic. Fundamental adhesion refers to the forces that exist on the surface (to form the interfacial layer) and affect the bond strength between asphalt and aggregate. The tendency of these forces to form a surface is known as “surface energy,” which is defined as the amount of work required to form a unit area of the surface in vacuum.

According to Fowkes (1962), the SFE of a material has two components: a nonpolar/dispersive element (intermolecular forces such as Lifshitz–van der Waals, LW, forces) and a polar element (acid–base, AB, interactions such as hydrogen bonding). Lifshitz–Van der Waals forces consist of London dispersion forces, Debye induction forces, and Keesom orientation forces. Good and Van Oss (1988) further categorized the polar component in Lewis acid and Lewis base surface parameters. A linear combination of these forces to calculate total SFE value is shown in Equation 4.1:

$$\Gamma^{\text{Total}} = \Gamma^{\text{LW}} + \Gamma^{\text{AB}} = \Gamma^{\text{LW}} + 2\sqrt{\Gamma^+ \Gamma^-} \quad (4.1)$$

where

- Γ^{Total} = Total SFE
- Γ^{LW} = Nonpolar component
- Γ^+ = Lewis acid component
- Γ^- = Lewis base component
- Γ^{AB} = Acid–base component

This theory is also known as the three-component theory or acid–base theory, which is preferred over the Fowkes two-component theory because it facilitates better clarification of the types of interactions between different components in a mix.

The asphalt binder and aggregate SFE components were measured using a sessile drop device. The nomenclature for SFE components of asphalt binder and aggregate are $(\Gamma_b^{\text{LW}}, \Gamma_b^-, \Gamma_b^+)$ and $(\Gamma_s^{\text{LW}}, \Gamma_s^-, \Gamma_s^+)$, respectively.

In this research, a sessile drop apparatus (Figure 4.1) developed by Kyowa Interface Co. Ltd. in Japan was used to measure material contact angle. The University of Illinois at Urbana-Champaign owns the latest version of this instrument, from Drop Master Series, with a DM501/701 model for surface analysis. The FAMAS (interface measurement and analysis system) software supplied with the device measures the contact angles at a specified time interval in addition to measuring other details, such as drop volume and drop dimensions.

To determine surface energy using the sessile drop equipment, a specific set of probe liquids is required. The probe liquids are based on the surface tension value of liquids compared with the bitumen or aggregate used (surface tension value of substrate < surface tension of probe liquids used) (Little and Bhasin 2006). In this context, Table 4.1 lists the probe liquids selected for testing the various bitumen types and aggregate, respectively.

Table 4.1 Probe Liquids Used for Sessile Drop Equipment with Asphalt Binder and Aggregate

	Asphalt Binder	Aggregate
Probe Liquids	Water	Water
	Glycerol	Glycerol
	1-Diiodomethane	1-Diiodomethane
	Formamide	—
	Ethylene Glycol	—

When using the automatic dispenser, the volume of the droplet is administered by the software automatically, and an image of the droplet on the bitumen surface is captured by the FAMAS software to record the advancing contact angle as an average value and the standard deviation for three observations. The measured contact angle of the probe liquid droplet on the substrate represents an average of the angles measured on the left and right of the placed droplet, as shown in Figure 4.2.

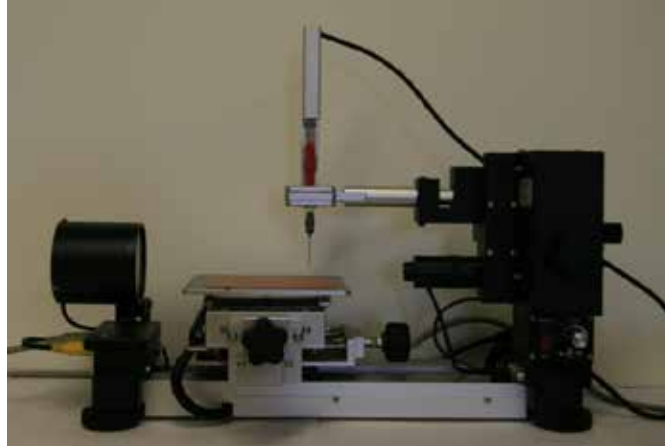

Figure 4.1 Sessile drop device and angle measurement.

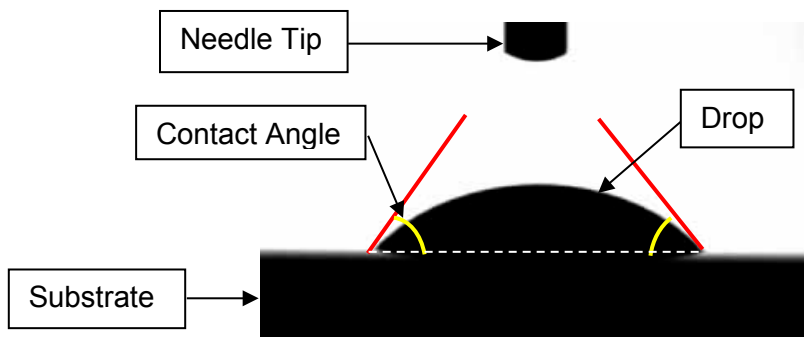

Figure 4.2 Contact angle measurement.

When preparing bitumen samples for contact angle measurement, a smooth, clean, and horizontal surface of the specimen must be maintained. For that purpose, special molds of aluminum were fabricated with a square base plate of 2×2 in cross section (5×5 cm) and a height of 0.2 in (5 mm). Clips were affixed all four sides (as shown in Figure 4.3) to prevent asphalt binder flow and maintain the proper shape and a level surface.

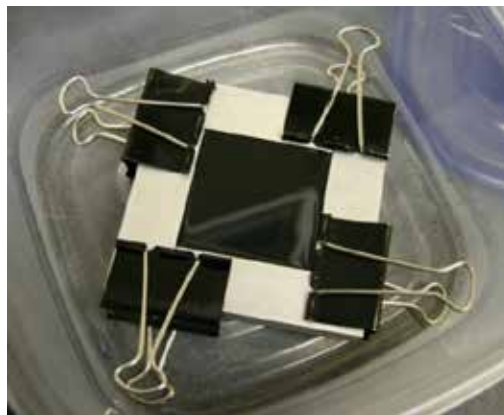

Figure 4.3 SFE asphalt binder sample.

The asphalt binder sample was heated until it reached a flowable state. Then the sample was transferred to aluminum cups (Figure 4.4) that could be bent to direct the flow of the asphalt binder. Meanwhile, side components of molds were fixed onto base plates using binder clips. Hot asphalt binder was poured in each mold such that a horizontal surface was formed. After 24 hr, the side components of molds were removed and the asphalt binder sample was ready for measurement on the sessile drop device.



Figure 4.4 Aluminum cups used for asphalt binder transfer.

To determine work of adhesion between aggregate and asphalt binder, surface energy components (LW, + and -) must be determined for aggregates used in the asphaltic mixture. For this project, limestone was the primary aggregate type used in the asphalt mixtures.

Aggregate samples were prepared for testing by the sessile drop device. Aggregate samples (to a thickness of 5 mm) with a polished smooth, horizontal surface were prepared and tested using the same procedure performed on asphalt binder samples (Figure 4.5).



Figure 4.5 Aggregate samples prepared for contact angle measurements.

The contact angle measured between a probe liquid and a solid substrate can be linked to SFE components through the following Young–Dupré relation:

$$0.5 \times \Gamma_L^{\text{Total}} \times (1 + \cos\theta) = 2\sqrt{\Gamma_L^{\text{LW}}\Gamma_m^{\text{LW}}} + 2\sqrt{\Gamma_L^+\Gamma_m^-} + 2\sqrt{\Gamma_L^-\Gamma_m^+} \quad (4.2)$$

where $(\Gamma_L^{\text{Total}}, \Gamma_L^{\text{LW}}, \Gamma_L^-, \Gamma_L^+)$ and $(\Gamma_m^{\text{LW}}, \Gamma_m^-, \Gamma_m^+)$ represent the SFE components of probe liquid and the substrate material (i.e., asphalt binder or aggregate), respectively. A minimum of three liquids is required to determine the three unknown SFE components of asphalt binder and aggregate. As shown in Table 4.1, five probe liquids were used for asphalt binder and three probe liquids were used for aggregate. The nomenclature for SFE components of asphalt binder and aggregate is $(\Gamma_b^{\text{LW}}, \Gamma_b^-, \Gamma_b^+)$ and $(\Gamma_s^{\text{LW}}, \Gamma_s^-, \Gamma_s^+)$, respectively.

Certain thermodynamic variables based on the concept of surface energy are used to describe the sensitivity of an asphalt mixture to moisture, which are discussed in the following sections.

4.2.1.1 Work of Adhesion

Work of adhesion is the amount of work required to separate two materials (i.e., aggregate and asphalt binder) at the interface. For two materials in contact with each other, the energy required to separate them is equal to the sum of individual surface energies of the components reduced by a portion of the intermolecular forces existing on the interface. According to the acid–base theory, work of adhesion is calculated as shown in Equation 4.3 (Young–Dupré equation):

$$W_{S,b}^a = 2\sqrt{\Gamma_s^{\text{LW}}\Gamma_b^{\text{LW}}} + 2\sqrt{\Gamma_s^+\Gamma_b^-} + 2\sqrt{\Gamma_s^-\Gamma_b^+} \quad (4.3)$$

4.2.1.2 Work of Cohesion

Work of cohesion (for asphalt binder) is defined as the amount of work done on a system to reversibly separate a column (liquid/solid) of unit area into two new surfaces (each of unit area). It is given as surface energy value times the amount of new surfaces created, as shown in Equation 4.4:

$$W_{b,b}^a = 2\sqrt{\Gamma_b^{\text{LW}}\Gamma_b^{\text{LW}}} + 2\sqrt{\Gamma_b^+\Gamma_b^-} + 2\sqrt{\Gamma_b^-\Gamma_b^+} = 2\Gamma_b^{\text{LW}} + 4\sqrt{\Gamma_b^+\Gamma_b^-} \quad (4.4)$$

Figure 4.6 (on the following page) illustrates the concepts of work of adhesion and cohesion in more detail.

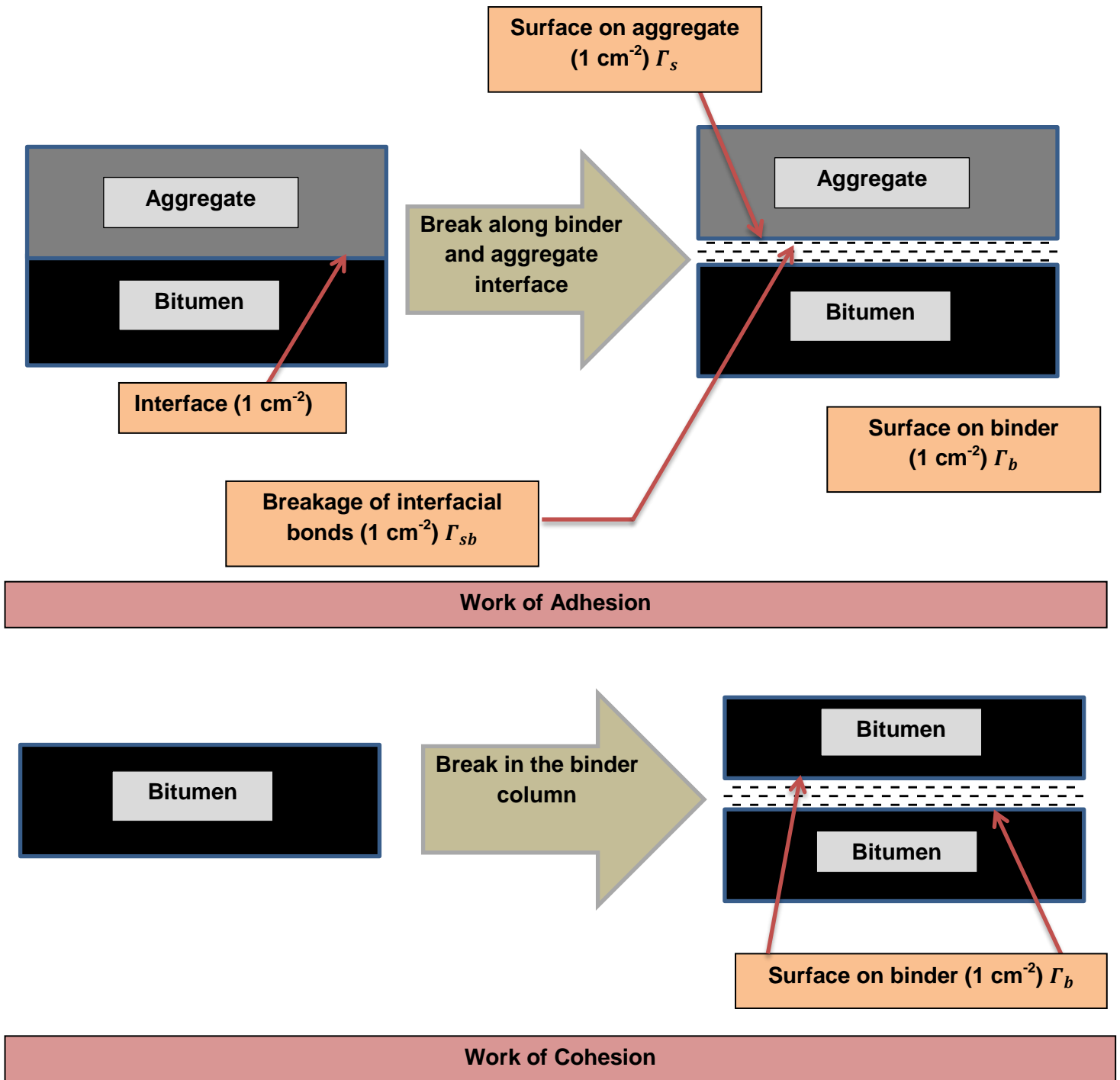

Figure 4.6 SFE-based evaluation parameters: work of adhesion (top), and work of cohesion (bottom).

4.2.1.3 Interfacial Energy (Γ_{ij}) and Work of Debonding (W_{bsw}^{wet})

The interfacial energy between two materials, i and j, using their SFE components is calculated as shown in Equation 4.5 (Bhasin et al. 2001; Cheng et al. 2003; Caro 2009):

$$\Gamma_{ij} = \Gamma_i^{Total} + \Gamma_j^{Total} - 2\sqrt{\Gamma_i^{LW}\Gamma_j^{LW}} - 2\sqrt{\Gamma_i^+\Gamma_j^-} - 2\sqrt{\Gamma_i^-\Gamma_j^+} \quad (4.5)$$

where

$$\begin{aligned} \Gamma_i^{Total}, \Gamma_j^{Total} &= \text{Total SFE for materials i and j, respectively} \\ \Gamma_i^{LW}, \Gamma_i^+ \& \Gamma_i^- &= \text{SFE components for material i} \\ \Gamma_j^{LW}, \Gamma_j^+ \& \Gamma_j^- &= \text{SFE components for material j} \end{aligned}$$

The work of debonding between the aggregate and the asphalt binder in the presence of water is calculated using Equation 4.6 (Bhasin et al. 2001; Wasiuddin et al. 2007a, Caro 2009):

$$W_{bsw}^{wet} = \Gamma_{bw} + \Gamma_{sw} - \Gamma_{bs} \quad (4.6)$$

where

$$\begin{aligned} \Gamma_{bw} &= \text{Interfacial energy between asphalt binder and water} \\ \Gamma_{bs} &= \text{Interfacial energy between asphalt binder and aggregate} \\ \Gamma_{sw} &= \text{Interfacial energy between aggregate and water} \end{aligned}$$

4.2.1.4 Compatibility Ratio (ER_1)

Critical parameters affecting moisture sensitivity of a bituminous mix ($W_{S,b}^a$, $W_{b,b}^a$, W_{bsw}^{wet}) can be represented by a single parameter, the energy ratio (ER_1). As discussed earlier, asphalt binder has less tendency to strip from the aggregate surface when bond strength (or work of adhesion) increases. In comparison, damage caused by water is less when the energy from induction of moisture in the aggregate–asphalt binder assembly is reduced (i.e., work of debonding is insignificant). Accordingly, the energy ratio, as shown in Equation 4.7 can be used to predict moisture susceptibility in an asphaltic mixture (mixtures with high ER_1 are less sensitive to moisture damage):

$$ER_1 = \left| \frac{W_{S,b}^a}{W_{bsw}^{wet}} \right| \quad (4.7)$$

4.2.2 Direct Adhesion Test (DAT)

The DAT evaluates adhesion at the asphalt binder–aluminum interface. Aluminum was selected because it is compatible with asphalt binder, easily available, and has low diffusion, controllable roughness, high resistance to extreme temperatures, and a thermal coefficient similar to that of aggregates (Fini and Al-Qadi 2011). In addition, the surface energy of aluminum is relatively low compared with that of aggregate.

The assembly consisted of two half-cylinder aluminum parts 1 in (25 mm) in diameter and 0.47 in (12 mm) long (Figure 4.7). A half-cylinder mold, with the upper part open, was placed between the aluminum parts on a level surface. The asphalt binder poured into the mold was therefore confined between the two end pieces. A pre-debonded area in the form of a crack at one side of the asphalt binder–aluminum interface was created to ensure that adhesive failure occurred and to define the failure’s location. To create the crack, a 1 x 0.08 in (25 x 2 mm) shim was placed on the upper edge of the aluminum piece on the fixed side of the direct tension test fixture. The shim was removed after the asphalt binder was poured and cooled, leaving a notch 0.08 in (2 mm) deep, which is the initial failure location at the aluminum–asphalt binder interface.

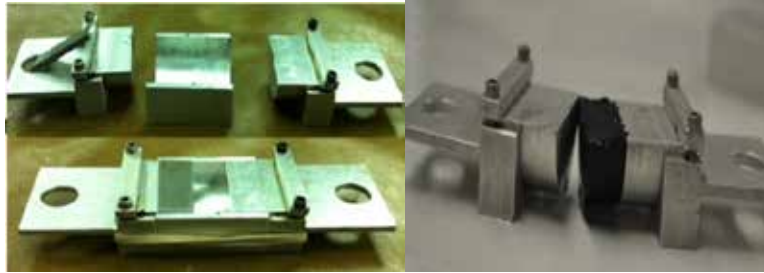

Figure 4.7 DAT specimen fixture.

The two half-cylinder aluminum parts were assembled. Then, to facilitate separating the asphalt binder sample after it cooled down, the mold and the shim were sprayed with a silicon-based release agent. The assembly was secured and placed on a base plate. The heated asphalt binder was poured into the mold from one corner to avoid formation of air bubbles. The sample was left for 1 hr of annealing at room temperature, after which the specimen was trimmed and placed in a cooling bath for 15 min. The specimen was then removed from the bath, demolded, and placed back in the bath for another 45 min to allow for equilibration before testing was initiated.

The outcome of the DAT is a curve representing load versus displacement. The maximum load, P_{max} , and bond energy, E , can be calculated for each asphalt binder–aluminum pair, as shown in Figure 4.8. The higher the P_{max} and E , the better the adherence properties of the asphalt binder. Using the setup described above, the four asphalt binder types (six replicates of each type) were tested at a temperature of 39.2°F (4°C). The area under the load-displacement curve can be divided by the contact cross area to calculate the energy. Because a debonded area was created and the failure path was defined, no energy was dissipated in crack initiation, which helps obtain consistent results.

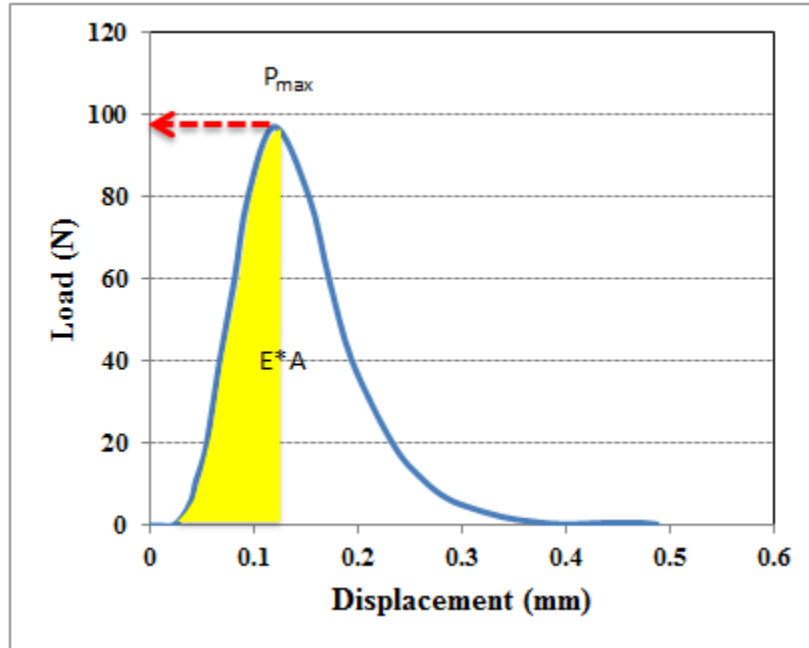

Figure 4.8 Typical DAT result.

4.3 TEST RESULTS AND DISCUSSION

The complex modulus (G^*) for each asphalt binder was measured using the DSR at various temperatures: 39.2°F, 50°F, 60.8°F, 71.6°F, 82.4°F, 93.2°F, 104°F, 114.8°F, 125.6°F, 136.4°F, 147.2°F, and 158°F (4°C, 10°C, 16°C, 22°C, 28°C, 34°C, 40°C, 46°C, 52°C, 58°C, 64°C, and 70°C). From the collected data, the master curve for each asphalt binder was developed. Figure 4.9 displays the G^* measurement for all four asphalt binders with RTFO aging.

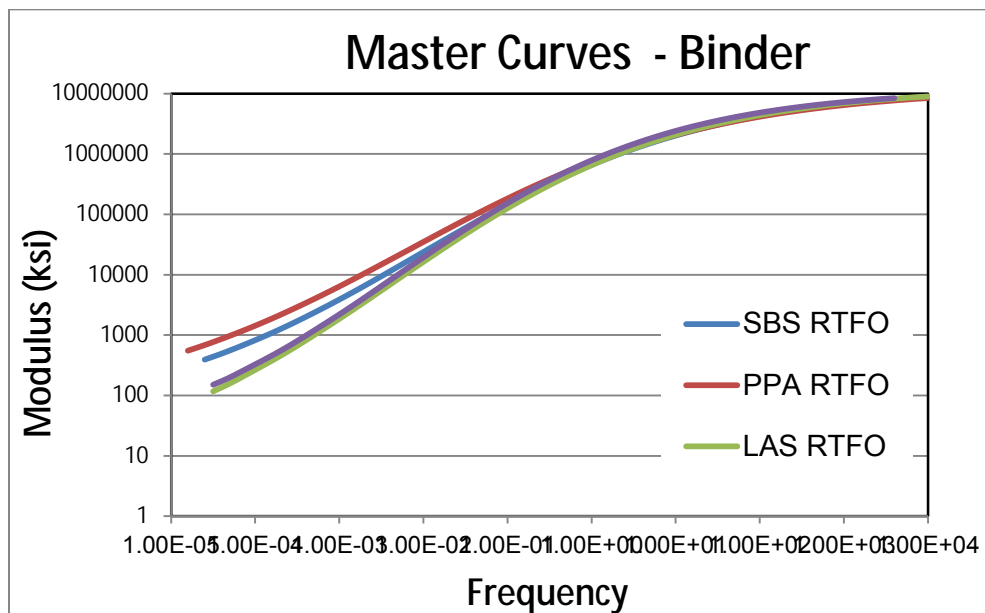

Figure 4.9 Binder master curves.

The only difference between asphalt binders appeared at the high-temperature (low-frequency) side of the master curve. Asphalt binders at the low-temperature (high-frequency) portion of the master curve appear identical because all asphalt binders had the same low-temperature PG and all were produced with the same neat asphalt binder.

As expected, the asphalt binder with SBS and the asphalt binder with PPA were stiffer than the control asphalt binder and the asphalt binder with LAS at high temperatures. This is because the asphalt binders with either SBS or PPA had a PG of 70-22, while the control asphalt binder and the asphalt binder with LAS had a PG of 64-22. The control asphalt binder was slightly stiffer than the asphalt binder with LAS. Adding LAS is reported to soften asphalt binder (Berthelot et al. 2010). PPA produced a stiffer asphalt binder compared with binder modified with SBS.

4.3.1 Surface Free Energy (SFE) Test

Tables 4.2 and 4.3 show the measured SFE components for asphalt binder and aggregate, respectively. Table 4.4 presents results for both the work of adhesion and cohesion. Table 4.5 presents the values of the free energy released in the presence of moisture for each aggregate and asphalt binder combination along with the compatibility ratio (ER_1).

Table 4.2 SFE Components of Asphalt Binder

Asphalt	Surface Energy Components (ergs/cm ²)			
	Lifshitz–van der Waals	Acid	Base	Total
PG 64-22 (Control)	30.72	0.78	1.64	32.98
Control + LAS	35.22	1.42	9.71	42.64
Control + PPA	32.67	0.85	1.93	35.22
Control + SBS	30.55	0.66	1.63	32.63

Table 4.3 SFE Components of Aggregate

Aggregate	Surface Energy Components (ergs/cm ²)			
	Lifshitz–van der Waals	Acid	Base	Total
Dolomitic Limestone	45.57	2.68	39.21	66.06

Table 4.4 Work of Adhesion Results

Asphalt Binder	Aggregate	Work of Adhesion (ergs/cm ²)	Work of Cohesion (ergs/cm ²)
PG 64-22 (Control)	Dolomitic Limestone	90.06	65.96
Control + LAS	Dolomitic Limestone	105.23	85.3
Control + PPA	Dolomitic Limestone	93.23	70.45
Control + SBS	Dolomitic Limestone	88.99	65.26

Table 4.5 Free Energy Released in the Presence of Moisture, and ER₁ Calculations

Combination	W _{bsw} ^{wet}	ER ₁
PG 64-22 (Control) with Dolomitic Limestone	19.28	4.67
Control + LAS with Dolomitic Limestone	9.12	11.54
Control + PPA with Dolomitic Limestone	19.33	4.82
Control + SBS with Dolomitic Limestone	19.07	4.67

The data in Tables 4.2 and 4.3 are consistent with the findings of Little and Bhasin (2006) showing aggregate to have a higher SFE compared with asphalt binder and that aggregate has a significantly higher base than acid component. Likewise, Table 4.2 shows that the asphalt binder with LAS had the highest total SFE compared with the other asphalt binders.

Table 4.4 shows that the asphalt binder with LAS resulted in the highest values for both work of adhesion and cohesion. This finding suggests a good potential performance and higher resistance to moisture compared with other asphalt binder types in this study. On the other hand, PPA slightly improved the work of adhesion and cohesion when added to the control asphalt binder. SBS, when added to control asphalt binder, slightly reduced the work of adhesion and had almost no effect on the work of cohesion compared with control asphalt binder.

Table 4.5 provides better understanding as to the performance of asphalt binders in combination with dolomitic limestone aggregate. Asphalt binder treated with LAS resulted in the lowest free energy released in the presence of moisture and the highest ER₁ ratio compared with other asphalt binders. This is a direct indication that the mix using asphalt binder treated with LAS will be the least prone to moisture damage. On the other hand, compared with the control mix, mixtures with SBS or PPA did not have a significant effect with regard to work of adhesion, work of cohesion, and energy released in the presence of moisture.

These findings appear to correlate well with results from the modified AASHTO T283 test (Tables 2.7 and 2.8). Both the modified AASHTO T283 and SFE tests show that asphalt binder treated with LAS reduced moisture susceptibility of the control mix. Generally, this finding provides additional support for applying the SFE concept to predict moisture susceptibility of asphalt mixtures prior to mix design. However, asphalt binder with LAS may be affected by storage period.

Table 4.6 displays the SFE values for control asphalt binder mixed with LAS; the contact angles were measured at different storage times. The measurements were performed in an attempt to gain a better understanding of the challenges users face when adding LAS to asphalt binders. These challenges include thermal degradation, long-term field performance, and heat instability (Wasiuddin et al. 2007b). Table 4.6 clearly shows that the total SFE dropped significantly after the asphalt binder with LAS had been stored. Although total SFE after two months of storage is greater than that of one month, the drop in SFE compared with that of no storage time is significant. More testing needs to be performed on different asphalt binders containing various LAS types in order to build a solid conclusion. This preliminary finding supports the efficiency of the SFE test in capturing such effects in addition to its ability to rank different material based on their moisture susceptibility, as discussed earlier.

An important caveat about this study is that the SFE results were based on aggregate SFE components measured using a sessile drop device.

Table 4.6 SFE Components of Control Asphalt Binder with LAS vs. Storage Time

Asphalt	Surface Energy Components (ergs/cm ²)			
	Lifshitz–van der Waals	Acid	Base	Total
Control + LAS, No Storage	35.22	1.42	9.71	42.64
Control + LAS, 1 Month Storage	15.12	0.09	3.49	16.23
Control + PPA, 2 Month Storage	24.20	0.46	3.33	26.67

4.3.2 Direct Adhesion Test (DAT)

Table 4.7 displays the P_{max} and E values for all asphalt binders, showing that adding PPA, SBS, and LAS increased the P_{max} and E measured at the unaged stage compared with the control (PG 64-22) asphalt binder. The P_{max} and E values of the asphalt binders with PPA and LAS decreased with aging (using a rolling thin-film oven, RTFO). For the asphalt binder with SBS, the E value also decreased with aging; however, its P_{max} value increased slightly with aging. Asphalt binder treated with LAS showed the highest P_{max} and E for unaged and RTFO aging conditions. This finding indicates yet again that the LAS treatment of asphalt binder enhances its adhesive performance, which leads to the conclusion that asphalt binder with LAS will improve adherence properties with aggregate and result in mixes less vulnerable to moisture in the short term; further investigation is needed to evaluate long-term performance, as also suggested by the accelerated testing results. The results from the DATs are in agreement with those of the modified AASHTO T283 test discussed in Chapter 2.

Table 4.7 DAT Asphalt Binder Results

Asphalt Binder	P_{max} (N)	E (MPa)
PG 64-22, Virgin	30.13	0.008
LAS, Virgin	40.78	0.017
LAS, RTFO	37.82	0.011
PPA, Virgin	37.09	0.014
PPA, RTFO	27.48	0.005
SBS, Virgin	26.03	0.011
SBS, RTFO	28.92	0.007

1 MPa = 145 psi; 1 N = 0.224 lb

4.4 FINDINGS

This chapter presented a discussion of the feasibility of using SFE and DAT tests to evaluate moisture susceptibility of asphalt mixtures. The control asphalt binder was PG 64-22. The impact of using additives/modifiers (LAS, PPA, and SBS) on the moisture susceptibility of asphalt mixtures was evaluated. Each additive/modifier was added to the control asphalt binder, and the modified asphalt binder was evaluated using the aforementioned tests. Surface free energy was also determined for dolomitic limestone aggregate by measuring contact angles with a sessile drop device.

The results from the tests were compared with a typical standard test used primarily for moisture damage evaluation, the modified Lottman AASHTO T283 test. The findings are as follows:

- SFE values show that asphalt binder with LAS had the highest works of adhesion and cohesion compared with other binders. Asphalt binder treated with LAS also resulted in the highest compatibility ratio (ER_1).
- The effect of storage time on binder with LAS was captured by SFE values.
- DAT results showed that the adhesive parameters (P_{max} and E values) were the highest for asphalt binder treated with LAS.
- SFE and DAT results indicate that adding PPA and SBS did not improve moisture sensitivity of the asphaltic mixtures.
- The findings indicate that the SFE test and DAT results correlate with the findings from the modified AASHTO T283 test results presented in Chapter 2. These findings demonstrate the ability of SFE and DTA tests in detecting the effects of the additive (LAS) and modifiers (PPA and SBS) on moisture sensitivity of asphaltic mixtures.

4.5 RECOMMENDATIONS

Determining the SFE values and DAT parameters for a larger group of asphalt binders and aggregates is recommended as a means for building a database to screen asphalt binder–aggregate compatibility for moisture damage. The database would also enable researchers to establish reasonable thresholds for SFE values and DAT parameters to better control moisture susceptibility of asphaltic mixes.

CHAPTER 5 SUMMARY, CONCLUSIONS, AND RECOMMENDATIONS

5.1 SUMMARY

Various additives and modifiers are often used to enhance the performance of asphalt mixtures. However, some additives and modifiers may impact the moisture susceptibility of asphaltic mixtures. The objective of this study was to investigate the contribution of various additives and modifiers to moisture susceptibility of asphalt concrete. Two typical Illinois asphalt mixes (N70 and N90) that were considered to be moisture susceptible were selected along with four additives/modifiers: liquid anti-strip (LAS), styrene butadiene styrene (SBS), polyphosphoric acid (PPA), and hydrated lime. The moisture susceptibility of the mixes was evaluated using the Illinois modified AASHTO T283-02 test. The effect of the additives and modifiers was further evaluated by conducting a Lottman AASHTO T283-02 test with five freezing and thawing cycles, a wheel tracking test, and a fracture test.

Accelerated pavement testing (APT) was conducted on full-scale pavement sections, field paved sections placed with conventional contractor equipment. The pavement sections were built to validate the laboratory findings. Component-level tests to determine surface free energy (SFE) and direct adhesion test (DAT) parameters were performed to evaluate the effects of the control asphalt binder and control asphalt binder modified with either LAS, PPA, or SBS in controlling moisture damage. SFE was also determined for dolomitic limestone aggregate.

5.2 FINDINGS

The following findings are based on the results of the mixture-level tests, APT, and component-level tests:

- With the exception of SBS and hydrated lime, additives and modifiers reduced the unconditioned tensile strength of mixes. Both LAS and hydrated lime showed the ability to maintain strength characteristics of asphaltic mixtures after severe environmental conditioning.
- The mixes with hydrated lime resulted in the second highest tensile strength ratio (TSR) values. For N70, there was negligible difference between the slurry and marination hydrated lime addition approach and between the dry and wet techniques. For N90, all hydrated lime treatment techniques appeared to have very similar effects on asphaltic mixture performance.
- Compared with all other additives and modifiers, mixes with SBS and hydrated lime (added wet or marinate aggregate) showed the lowest potential for rutting as indicated by the wheel tracking test (WTT). It is expected that asphaltic mixtures with SBS perform as such because of the higher high-temperature grade of the asphalt binder. On the other hand, mixes with LAS had reduced rutting resistance, and PPA further reduced rutting resistance compared with the control mix.
- Significant improvement in the fracture energy of the N70 control mix resulted when LAS, SBS, hydrated lime wet, or hydrated lime marination was used. The mix with PPA had the lowest fracture energy.
- For the N90 mixes, all of the tested additives and modifiers reduced fracture energy compared with the control mix, except for mixes with hydrated lime (marination

process) and hydrated lime (wet process). However, it should be noted that the reduction was negligible when LAS was added.

- SFE results showed that asphalt binder with LAS had the highest works of adhesion and cohesion. Asphalt binder treated with LAS also resulted in the highest compatibility ratio (ER_1). Based on limited testing, it was found that storage time of asphalt binder with LAS reduced the SFE value and that thermal degradation might occur.
- DAT results showed that the adhesive parameters (P_{max} and E values) were the highest for asphalt binder treated with LAS.
- Among all the tested additives and modifiers, asphalt mixes with PPA resulted in the lowest TSR values, while mixes with LAS resulted in the highest, though it may be equally important to closely monitor conditioned and unconditioned strength values because the additives and modifiers had varying effects on the individual strengths, which can give misleading TSR results.
- All methods of hydrated lime addition reduced rutting potential; wet hydrated lime application or marination appears to result in better performance.
- Significant improvement in the fracture energy of the N70 control mix resulted when LAS, SBS, hydrated lime wet, and hydrated lime marination were used. The mix with LAS had the highest fracture energy, while the mix with PPA had the lowest fracture energy of the modified materials. Adding PPA or lime slurry to the N70 control mixes resulted in negligible improvement in fracture energy, but did not show a negative impact. It should be noted that the fracture energy test is a function of loading rate, and any interpretation of those test results should take that fact into consideration.

5.3 CONCLUSIONS

The main conclusions from this study are as follows:

- LAS or hydrated lime can be effective in controlling asphaltic mixture moisture damage when used with moisture-susceptible mixes. Hydrated lime maintained conditioned tensile strength better than other evaluated additives/modifiers. However, LAS additive may reduce the tensile strength of unconditioned asphalt mix specimens in spite of achieving high TSR values.
- PPA addition to the N70 and N90 asphalt mixes in this study resulted in greater vulnerability to moisture damage. Hence, it is suggested that PPA be used with other additives/modifiers in moisture-susceptible asphaltic mixtures.
- Component-level tests appear to be promising tools for detecting the ability of the additives and modifiers to control moisture damage. SFE testing can be used to characterize mixture component materials for possible moisture susceptibility. In addition, SFE data may be used to evaluate the effect of storage time on asphalt binder with LAS.
- Though the mix was greatly affected by moisture damage, as expected, the SBS addition provided the highest mix strength and was equal to the mix with hydrated lime wet. This indicates that SBS partially fulfills the intended purpose, but when used in certain climatic/environmental conditions, the increased susceptibility to moisture damage could overshadow the intended improvements.

5.4 RECOMMENDATIONS

In light of the above findings and conclusions, the authors offer the following recommendations:

- PPA should be used with other additives/modifiers only to control a potential increase in moisture damage of asphaltic mixtures.
- Consider conducting more-aggressive moisture-conditioning tests that include at least three cycles of freezing and thawing. This testing might require changing the strength threshold of conditioned specimens as well as the TSR threshold value.
- Obtain SFE values and DAT parameters on a larger group of asphalt binders and aggregates as a means for building a database to screen asphalt binder–aggregate compatibility against moisture damage. The database would also enable researchers to establish reasonable thresholds for SFE values and DAT parameter values to design asphaltic mixtures with less susceptibility to moisture.
- Determine SFE values for different asphalt binders with and without various LAS additives and different storage periods.
- Conduct testing on asphaltic mixes with PPA and hydrated lime or PPA with SBS to better understand the PPA contribution to the mix performance.

REFERENCES

- Berthelot, C., A. Anthony, C. Wandzura, and B. Marjerison. Triaxial Frequency Sweep Characterization of Asphalt-Aggregate Adhesion in Saskatchewan Asphaltic Mixes. *Journal of Transportation Engineering*. Vol. 136, No. 2, 2010, pp. 158–164.
- Bhasin, A., D. N. Little, K. L. Vasconcelos, and E. Masad. Surface Free Energy to Identify Moisture Sensitivity of Materials for Asphalt Mixes. In *Transportation Research Record: Journal of the Transportation Research Board*, No. 2001, Transportation Research Board of the National Academies, Washington, D.C., 2007, pp. 37–45.
- Bhasin, A., and D. Little. Application of Microcalorimeter to Characterize Adhesion Between Asphalt Binders and Aggregates. *Journal of Materials in Civil Engineering*. Vol. 21, No. 6, 2009, pp. 235–243.
- Birgisson, B., R. Roque, G. C. Page, and J. Wang. Development of New Moisture-Conditioning Procedure for Hot-Mix Asphalt. In *Transportation Research Record: Journal of the Transportation Research Board*, No. 2001, Transportation Research Board of the National Academies, Washington, D.C., 2007, pp. 46–55.
- Buncher, M. Establishing a Baseline of Knowledge (through 2005) by Reviewing AI IS-220 “Polyphosphoric Acid Modification of Asphalt.” Presented at the Annual Conference of the American Association of Paving Technologists, 2010.
- Caro, S. S. A Coupled Micromechanical Model of Moisture-Induced Damage in Asphalt Mixtures: Formulation and Applications. Doctoral dissertation, Texas A&M University, 2009.
- Caro, S., E. Masad, A. Bhasin, and D. N. Little. Moisture Susceptibility of Asphalt Mixtures, Part 1: Mechanisms. *International Journal of Pavement Engineering*. Vol. 9, No. 2, 2008(a), pp. 81–98.
- Caro, S., E. Masad, A. Bhasin, and D. N. Little. Moisture Susceptibility of Asphalt Mixtures, Part 2: Characterisation and Modelling. *International Journal of Pavement Engineering*. Vol. 9, No. 2, 2008(b), pp. 99–114.
- Chen, C., A. A. Tayebali, and D. R. U. Knappe. A Procedure to Quantify Organic Antistrip Additive in Asphalt Binders and Mixes. *Journal of Testing and Evaluation*. Vol. 34, No. 4, 2006, pp. 269–274.
- Cheng, D. X., D. N. Little, R. L. Lytton, and J. C. Holste. Moisture Damage Evaluation of Asphalt Mixture by Considering Both Moisture Diffusion and Repeated Load Conditions. In *Transportation Research Record: Journal of the Transportation Research Board*, No. 1832, Transportation Research Board of the National Academies, Washington, D.C., 2003, pp. 42–58.
- Cho, D.-W., and H. U. Bahia. Effects of Aggregate Surface and Water on Rheology of Asphalt Films. In *Transportation Research Record: Journal of the Transportation Research Board*, No. 1998, Transportation Research Board of the National Academies, Washington, D.C., 2007, pp. 10–17.
- Expert Task Group, Federal Highway Administration. *Moisture Damage in Asphalt Mixtures—A State-of-the-Art Report*. Publication FHWA-RD-90-019. FHWA, U.S. Department of Transportation, 1990.

- Fini, E. H., and I. L. Al-Qadi. Development of a Pressurized Blister Test for Interface Characterization of Aggregate Highly Polymerized Bituminous Materials. *Journal of Materials in Civil Engineering*. Vol. 23, No. 5, 2011, pp. 656–663.
- Fowkes, F. M. Determination of Interfacial Tensions, Contact Angles and Dispersion Forces in Surfaces by Assuming Additivity of Intermolecular Interactions in Surfaces. *Journal of Physical Chemistry*. Vol. 66, No. 2, 1962, p. 382.
- Hao, P., and H. Y. Liu. A Laboratory Study of the Effectiveness of Various Additives on Moisture Susceptibility of Asphalt Mixtures. *Journal of Testing and Evaluation*. Vol. 24, No. 4, 2006, pp. 261–268.
- Huang, J. F., S. P. Wu, L. X. Ma, and Z. F. Liu. Material Selection and Design for Moisture Damage of HMA Pavement. *Materials Science Forum*. Vol. 614, 2009, pp. 269–274.
- Izzo, R. P., and M. Tahmooressi. Use of the Hamburg Wheel Tracking Device for Evaluating Moisture Susceptibility of Hot-Mix Asphalt. In *Transportation Research Record: Journal of the Transportation Research Board*, No. 1681, Transportation Research Board of the National Academies, Washington, D.C., 1999.
- Kringos, N., T. Scarpas, C. Kasbergen, and P. Selvadurai. Modelling of Combined Physical–Mechanical Moisture-Induced Damage in Asphaltic Mixes, Part 1: Governing Processes and Formulations. *International Journal of Pavement Engineering*. Vol. 9, No. 2, 2008(a), pp. 115–128.
- Kringos, N. A. Scarpas, A. Copeland, and J. Youtcheff. Modelling of Combined Physical–Mechanical Moisture-Induced Damage in Asphaltic Mixes, Part 2: Moisture Susceptibility Parameters. *International Journal of Pavement Engineering*. Vol. 9, No. 2, 2008(b), pp. 129–151.
- Li, X., M. Marasteanu, A. Kvasnak, J. Bausano, R. Williams, and B. Worel. Factors Study in Low-Temperature Fracture Resistance of Asphalt Concrete. *Journal of Materials in Civil Engineering*. Vol. 22, No. 2, 2010, pp. 145–152.
- Little, D. N., and A. Bhasin. *Using Surface Energy Measurements to Select Materials for Asphalt Pavement*. NCHRP Project 9-37. National Cooperative Highway Research Program, Transportation Research Board of the National Academies, 2006.
- Lu, Q., and J. T. Harvey. Long-Term Effectiveness of Antistripping Additives: Laboratory Evaluation. In *Transportation Research Record: Journal of the Transportation Research Board*, No. 1970, Transportation Research Board of the National Academies, Washington, D.C., 2006, pp. 14–24.
- Mallick, R. B., R. Pelland, and F. Hugo. Use of Accelerated Loading Equipment for Determination of Long-Term Moisture Susceptibility of Hot Mix Asphalt. Presented at the 84th Transportation Research Board Annual Meeting, Washington, D.C., 2005.
- Sebaaly, P. E., E. Hitti, and D. Weitzel. Effectiveness of Lime in Hot-Mix Asphalt Pavements. In *Transportation Research Record: Journal of the Transportation Research Board*, No. 1832, Transportation Research Board of the National Academies, Washington, D.C., 2003, pp. 33–41.
- Sebaaly, P. E., D. Little, E. Y. Hajj, and A. Bhasin. Impact of Lime and Liquid Antistrip Agents on Properties of Idaho Hot-Mix Asphalt Mixture. In *Transportation Research Record: Journal of the Transportation Research Board*, No. 1998, Transportation Research Board of the National Academies, Washington, D.C., 2007, pp. 65–74.

- Tarefder, R. A., and A. M. Zaman. Nanoscale Evaluation of Moisture Damage in Polymer Modified Asphalts. *Journal of Materials in Civil Engineering*. Vol. 22, No. 7, 2010, pp. 714–725.
- Terrel, R. L., and S. Al-Swailmi. *Water Sensitivity of Asphalt–Aggregate Mixes: Test Selection*. Publication SHRP-A-403, National Research Council, 1994.
- Turner-Fairbank Highway Research Center (TFHRC). Modification of Asphalt Binders with Phosphoric Acid Mix Tests. FHWA Office of Research, Development, and Technology . Presented at the Annual Conference of the American Association of Paving Technologists, 2010.
- Wasiuddin, N. M., C. M. Fogel, M. M. Zaman, and E. A. O’Rear. Effect of Anti-Strip Additives on Surface Free Energy Characteristics of Asphalt Binders for Moisture-Induced Damage Potential. *Journal of Testing and Evaluation*. Vol. 35, No. 1, 2007(a), pp. 36–44.
- Wasiuddin, N. M., C. M. Fogel, M. M. Zaman, and E. A. O’Rear. Characterization of Thermal Degradation of Liquid Amine Anti-Strip Additives in Asphalt Binders Due to RTFO and PAV-Aging. *Journal of Testing and Evaluation*. Vol. 35, No. 4, 2007(b), pp. 387–394.
- Van Oss, C. J., M. K. Chaudhury, and R. J. Good. Interfacial Lifshitz–van der Waals and Polar Interactions in Macroscopic Systems. *Chemical Reviews*. Vol. 88, No. 6, 1988, pp. 927–941.

APPENDIX A
LITERATURE REVIEW

1. INTRODUCTION AND SCOPE

1.1 INTRODUCTION

Moisture is one of the major sources of deterioration in flexible pavements. Moisture damage, defined as the degradation of the mechanical properties of asphalt concrete caused by moisture (Caro et al. 2008a), was first recognized as a serious problem in the early 1960s (Sebaaly et al. 2003). However, it was not until the 1980s that moisture damage gained the attention of highway agencies and the pavement industry (Caro et al. 2008a). Despite the improvements and developments of asphalt mixture design procedures and a better understanding of the mechanisms of moisture damage, it is still considered one of the most common and complex problems facing the pavement community (Wasiuddin et al. 2007). Moisture damage causes a severe loss in the strength and durability of asphalt pavements, leading to a major decrease in pavement performance. Moisture damage also contributes significantly to the premature deterioration of asphalt pavement, which results in an additional \$54 billion annual vehicle operating cost (Caro et al. 2008a).

Generally, the existence of moisture in asphalt pavements separates the asphalt film from aggregate particles, thus causing what pavement engineers call stripping. Stripping contributes to several distresses, including thermal or fatigue rutting, raveling, and cracking (Sebaaly et al. 2003; Cho et al. 2009). Therefore, moisture damage is not a failure mode, but it leads to and significantly accelerates the aforementioned failure modes. (Sebaaly et al. 2003). Hence, the aggregate-binder interface in the presence of water has been studied since 1932 (Caro et al. 2008a). Studying moisture damage is considered complex because of the interconnected various mechanisms that cause stripping. The moisture damage mechanisms are categorized into three main types (Cheng et al. 2003; Terrel et al. 1994):

1. Loss of cohesion and stiffness in asphalt mastic.
2. Loss of adhesion between the asphalt mastic and aggregates.
3. Degradation or fracture of aggregates because of freezing and thawing cycles.

The approaches for studying moisture damage include the following:

1. Evaluating traditional additives and modifiers used to mitigate moisture damage.
2. Evaluating and studying different aspects and causes of moisture damage.
3. Evaluating conventional moisture damage tests and comparing or correlating them with field results.
4. Studying and evaluating new additives and modifiers.
5. Developing new tests, parameters, and analytical methods to improve moisture- resistance and moisture-susceptibility predictions and measurements.

The moisture sensitivity of asphalt concrete depends on many factors, including aggregates and binders characteristics, asphalt mixture properties, environmental conditions (e.g., temperature and humidity), traffic loading, quality of construction, and pavement design (Sebaaly et al. 2007; Bhasin et al. 2007a; Hao et al. 2006).

Moisture susceptibility or sensitivity has been studied in the lab using several conventional test methods applied on loose and compacted samples. Most tests applied on compacted samples, such as Lottman test (AASHTO T283), which measures the mechanical properties of the asphalt mixture before conditioning (dry sample) and after conditioning (wet sample). A ratio is calculated and reported between these two measurements (wet and dry). The minimum accepted value for this ratio

differs from state to state. Other tests measure indices, such as the Hamburg wheel tracking test that measures a stripping index, which is the ratio of the difference in dry weight before and after testing to the dry weight before testing (Peiwen et al. 2006). These conventional tests that indicate asphalt concrete sensitivity to moisture are considered empirical tests and do not correlate well with the moisture sensitivity of pavements in the field (Kim et al. 2008).

Researchers have recently considered other testing approaches to overcome the deficiencies of the conventional tests. Concepts, such as surface-free energy (adhesion and cohesion energies), diffusion, and fracture parameters, are being considered (Kim et al. 2008). Modeling has also been introduced to help better understand moisture damage and to predict pre-construction pavement performance in the field.

1.2 SCOPE

This literature review discusses the main aspects of moisture damage. The review is divided into eight parts. The first part includes a brief introduction about moisture damage and its main aspects. The second part presents an overview of the mechanisms and different forms of moisture damage. The laboratory tests used to evaluate the moisture damage of asphalt are discussed in the third part, which also presents the development of laboratory moisture damage tests, classification of tests, and the difficulties facing their development. The fourth part focuses on the study of the aggregate-binder interface system and includes a detailed discussion about concepts like surface-free energy, modes of moisture transport, and diffusion. The fifth part covers the mathematical modeling of moisture damage as a new approach used to better understand and assist in the prediction of field performance. Many additives are used to mitigate the effect of moisture on asphalt concrete, and new types of additives are being produced, studied, and evaluated. The sixth part concentrates on the additives and modifiers used to mitigate moisture damage, such as lime, liquid anti-strip, polyphosphoric acid, and polymer modification. The seventh part includes a brief summary of the previous parts, and the eighth part lists the references utilized in this literature review.

2. MECHANISMS OF MOISTURE DAMAGE

When moisture or water occurs in asphalt concrete, it creates damage, and this damage is governed by a mechanism that consists of two stages (Caro et al. 2008a):

1. The transport of moisture (vapor or liquid) through asphalt concrete, asphalt binder, or mastic
2. The degradation of the mechanical properties of asphalt concrete and loss of its strength capacity because of moisture

Both stages are subject to the characteristics of asphalt and binder, asphalt mixture, environmental conditions, and traffic loading.

In general, the above responses can be categorized into three main types of moisture damage mechanisms (Cheng et al. 2003; Terrel et al. 1994):

1. Stripping: Loss of adhesion
2. Softening: Loss of cohesion
3. Aggregate degradation

Stripping is defined as the physical separation of asphalt binder or mastic from the aggregate as a result of the loss of adhesion caused by moisture (Caro et al. 2008a). The adhesion between the aggregate and asphalt binder or mastic depends primarily on seven factors (Terrel et al. 1994):

1. Binder viscosity
2. Chemical composition of binder and aggregate
3. Surface energy components of binder and aggregate
4. Cleanliness of aggregate
5. Amount of moisture in aggregate and mixing temperature
6. Aggregate porosity
7. Aggregate texture

Softening is a reduction in stability and strength caused by the loss of cohesion in asphalt binder because of moisture (Wasiuddin et al. 2007). Moisture affects cohesion of asphalt binder through intrusion, saturation, or swelling. Cohesion depends primarily on binder viscosity (Terrel et al. 1994).

When asphalt mixture is subjected to freezing and thawing cycles, aggregate is degraded due to fractured (Cheng et al. 2003).

The aforementioned three mechanisms take place in different forms because moisture transports into asphalt mixtures through different modes (Caro et al. 2008a):

1. Detachment: The separation of aggregate and mastic at the interface because of the existence of a thin film of water. This form is related to the stripping mechanism.
2. Displacement: In this response, the aggregate degrades as a result of breakage in the asphalt film and/or weakening of aggregate-binder bond at the interface. This form can be related to loss of adhesion and/or to aggregate degradation mechanisms.

3. Dispersion of mastic: The cohesive bond in the mastic weakens as a result of long-term diffusion periods. This form is related to the softening mechanism.
4. Desorption of mastic: The outer layers of the mastic are washed away because of the high-speed flow of moisture. Desorption is related to the softening mechanism.
5. Spontaneous emulsification: This form is also a type of softening mechanism, where droplets of water are emulsified inside the mastic.
6. Film rupture or microcracks: In this form, deterioration and microcracks occur in the aggregate or mastic. The microcracks generally reduce the strength of the asphalt concrete system and simultaneously open new paths for moisture to move through. This form can be related to the cohesion and aggregate degradation mechanisms.

3. LABORATORY EVALUATION OF MOISTURE DAMAGE

Transportation agencies and researchers have been studying moisture damage to come up with a measure to mitigate its severity. Most of the studies conducted by transportation agencies concentrate on two main aspects: (1) finding appropriate additives to be added to asphalt mixtures to mitigate moisture damage and (2) introducing methodologies and tests to specify, indicate, and measure moisture susceptibility of asphalt concrete (Caro et al. 2008a). These tests are necessary for predicting the level of damage that asphalt concrete is expected to incur because of moisture and developing standards to distinguish between acceptable and unacceptable moisture-resisting materials and mixtures (Caro et al. 2008b).

3.1. DEVELOPMENT OF MOISTURE DAMAGE PREDICTION TESTS

Pavement engineers concentrated their efforts on the development of tests to evaluate and capture moisture damage, sensitivity, or susceptibility and, at the same time, to study and evaluate the effect of different additives on moisture-susceptible materials. This approach was first considered at the beginning of the 20th century and is still being sought. Tarefder et al. (2009) conducted a comprehensive search on the evaluation tests and presented the following historical chain development: boil test (1930s, 1980s), absorption effects (1940s), sonic test (1950s), immersion compression (1950s), aggregate characteristics (1950s), water pressure pore size effect (1950s), thermally-induced pore pressure test (1960s), surface reaction test (1970s), pore pressure-double punch (1970s), cyclic water pressure strength (1970s), desorption by solvent extraction (1970s), inverse gas liquid chromatography (1980s), freeze-thaw pedestal (1980s), freeze-thaw conditioning with strength test (1970s, 1980s), tracking device (1970s, 1990s), asphalt pavement analyzer (1990s), pneumatic pull-off (1990s), net adsorption (1990s), environmental conditioning system (1990s), ultrasonic test (2000s), asphalt chemistry (2000s), cyclic pressure/suction (2000s), modified Lottman test or indirect tensile ratio test (1990s, 2000s), moisture-induced stress tester (2000s), AASHTO T-283 (2000s), Hamburg wheel track test (2000s), environmental conditioning system, and simple performance test (dynamic modulus and flow number) (2000s, ongoing).

Moisture damage undergoes physical, mechanical, chemical, and thermodynamic processes (Caro et al. 2008a), however, most of the above tests are based on comparing the mechanical properties of asphalt mixtures before and after the moisture-conditioning process (Bhasin et al. 2007a). Such approach does not capture the real cause for moisture damage and effects of asphalt concrete components (binder and aggregate) and mixture properties on moisture damage development (Bhasin et al. 2007a). In addition, most of the aforementioned tests fail to simulate the field conditions affecting asphalt concrete mixtures, such as environmental conditions, traffic, and time (Terrel et al. 1994); therefore, the results are always poorly correlated with field performance (Caro et al. 2008a, 2008b). Furthermore, the procedures followed by most of the above tests are empirical and their results depend on the moisture-conditioning methodology (Caro et al. 2008a).

These drawbacks encouraged researchers to develop a new set of tests that provided a more accurate moisture-sensitivity evaluation. The new tests investigated the components of asphalt mixtures (binder and aggregate) by studying their characteristics and establishing relationships to their susceptibility to moisture damage, as well determining the ability of different additives and modifiers to mitigate moisture damage (Caro et al. 2008a). The new tests study and measure the adhesive and cohesive properties, moisture mode of transport, and the identification and effect of these measurements on moisture-susceptible mixtures. Asphalt chemistry tests and cyclic pressure/suction tests are examples of the new tests that measure these new parameters. A detailed discussion of the surface free energy (SFE), adhesion, cohesion, and diffusion properties is included in Part 4 of this appendix.

3.2. CLASSIFICATION OF MOISTURE DAMAGE PREDICTION LABORATORY TESTS

Moisture damage prediction laboratory tests are classified based on several factors (Caro et al. 2008a):

1. Sample condition
2. Sample conditioning process
3. Loading type (static or dynamic)
4. Measured scale of performance (micro and macro scale)

Sample condition can be in one of three groups (Cho et al. 2007):

1. Tests applied on compacted samples such as Marshall stability test, Lottman test, immersion wheel tracking test, and Asphalt Pavement Analyzer (APA)
2. Tests applied on loose mixture samples such as water immersion method, electro-optic colorimetry test, and net adsorption test
3. Tests applied on the components of asphalt mixture (aggregate and binder) such as dynamic Wilhelmy plate method (DWPM), drying and wetting (soaking) tests for diffusion, and Universal sorption device test

Generally, the main difference between tests conducted on loose samples and those conducted on compacted samples is that the first focus on the visual inspection of aggregates coated with binder before and after the samples are subjected to moisture, while the second evaluate moisture damage by measuring a chosen mechanical property before and after the samples are subjected to moisture. Tests applied on compacted samples have the ability to better simulate and estimate the moisture effect because they are performance-related parameters; however, the contribution of asphalt binder properties, aggregate properties, and aggregate-binder bond on moisture damage phenomenon is not clear in these tests because such properties are distributed throughout the sample and combined with other mixture-related properties.

Whether the asphalt sample is loose or compacted, it should pass through a conditioning process. This conditioning process affects the outcomes of the applied test. The following are the most widely used conditioning processes (Birgisson et al. 2007):

1. Boiling loose samples for a period of time
2. Placing compacted samples in water bath for a period of time
3. Freezing and thawing cycles applied on compacted samples for a period of time
4. Vacuum-saturating compacted samples, then loading them with stresses to simulate traffic loads
5. Vacuum-saturating compacted samples, then applying pore pressure

These different conditioning processes are attempted to simulate field conditions during a short period of time considering accelerated damage process.

The moisture damage can be subjective, quantified using a performance index, or a presented as a moisture damage ratio (MDR).

The subjective qualification factor includes tests that are based on visual or qualitative assessment of moisture damage, such as boiling water test, static immersion test, and ultrasonic method. Quantification tests are conducted on loose and compacted samples with and without

loading, such as net adsorption, pneumatic pull-off, and surface energy tests. Each test has its unique performance parameter that is linked to moisture damage. These parameters are obtained from either chemical or mechanical tests. The MDR is based on finding a ratio between a measured parameter or multiple parameters under wet condition (conditioned) to the same parameter or parameters measured under dry condition (unconditioned). The tests are conducted using compacted asphalt samples. Each test's MDR has its own developed threshold to distinguish moisture-susceptible mixtures from other mixtures. These thresholds are developed based on relations of lab measurements to field measurements. Sometimes these thresholds are changed from one state to another depending on observations and studies. MDR allows evaluating the influence of several factors affecting moisture damage such as air void distribution or addition of additives and modifiers. Examples of tests used to calculate MDR are Lottman test, static creep test, and environmental conditioning system with dynamic modulus or flow number.

3.3 DIFFICULTIES IN DEVELOPING MOISTURE DAMAGE EVALUATION TESTS

The Expert Task Group (ETG) of the Federal Highway Administration (FHWA) prepared a comprehensive, state-of-the-art report regarding moisture damage. In this report, different aspects of moisture damage were studied including the tests used to evaluate moisture damage. According to this report, it is very difficult to develop a test that evaluates moisture damage accurately and simulates field performance because of the following reasons:

1. Properties of asphalt binder, temperature, and stresses change with the pavement layer.
2. Interactions between moisture damage and other failure mechanisms such as fatigue and thermal cracking. Fatigue and thermal cracking affect the degree of severity of moisture damage; cracks serve as new paths for moisture.
3. The simulation of field performance is very much related to ever changing factors such as environmental conditions, traffic loading levels, and air void distribution.
4. The properties of the produced plant asphalt mixture do not match the mix design. This results in invalid and misleading lab predictions.
5. Pavement properties depend on the season in which it was constructed. This affects the level of compaction and degree of initial densification under traffic.

It is considered a challenging task to develop a new method to evaluate and characterize moisture damage. The complexity is attributed to two main causes: first, moisture damage involves physical, mechanical, and chemical processes; and second, moisture damage is dependent on variables that are also function of time such as binder properties. It was concluded that much work was needed to develop a test or multiple tests that can accurately evaluate moisture damage and simulate the field performance.

4. BINDER–AGGREGATE INTERFACE SYSTEM: METHODS AND TECHNIQUES

Traditionally, moisture damage was evaluated through several tests using samples of compacted and loose asphalt mixtures. This approach isolated the understanding of the real causes of moisture damage, the effect of bond condition between aggregate and binder, and modes of transport of moisture inside asphalt concrete. The most important of recently developed methodologies are the ones that study moisture transport modes through asphalt concrete and concentrate on the moisture diffusion into asphalt concrete and the SFE by investigating binder cohesive bond and binder–aggregate adhesive bond (Caro et al. 2008a). These methodologies may provide the pavement community with a better understanding of the mechanisms of moisture damage. This section presents a detailed discussion of these methodologies and the SFE and diffusion parameters.

4.1. SURFACE-FREE ENERGY (SFE)

SFE is the amount of work or energy needed to form a unit area of a new surface of a material in vacuum. Any material, whether solid or liquid, has its own SFE. The best known theory to calculate the SFE for any material is the Van Oss-Chaudry-Good (VOCG) theory (Wasiuddin et al. 2007; Cheng et al. 2003; Bhasin et al. 2007a, 2007b, 2007c, 2009; Hao et al. 2006). This theory states that the SFE of any material is divided into three components: (1) a nonpolar component also called Lifhsitz-Van Der Waals or dispersive component; (2) the Lewis acid component; and (3) the Lewis base component. These components are referred to by the following symbols: Total SFE = Γ^{Total} , nonpolar component = Γ^{LW} , Lewis acid component = Γ^+ , Lewis base component = Γ^- , and acid-base component = Γ^{AB} . The total SFE of any material is determined based on the following equation:

$$\Gamma^{\text{Total}} = \Gamma^{\text{LW}} + \Gamma^{\text{AB}} = \Gamma^{\text{LW}} + 2\sqrt{\Gamma^+\Gamma^-} \quad (\text{A. 1})$$

The total SFE (Γ^{Total}) for any material can be determined by measuring Γ^{LW} , Γ^+ and Γ^- parameters and substituting them in Equation 1. SFE is calculated for binders and aggregate following the same process; however, measuring the three components for both binder and aggregate remains a challenge. Several devices are used to measure the SFE components of binder such as the Sessile drop device (Little et al. 2006). The DWPM—which depends on kinetic force equilibrium—is usually used for measuring the three SFE components of binder (Wasiuddin et al. 2007). In this simple method, a thin plate with binder on top is withdrawn from or immersed in a liquid solvent (Figure A.1). In the withdrawal and immersion processes, an angle is formed between the asphalt binder and liquid solvent (Figure A.2). During the withdrawal process, the dynamic contact angle formed is called the receding contact angle (RCA). During the immersion process, the dynamic angle formed is called the advancing contact angle (ACA) (Figure A.2). Most researchers measure only ACA because it is difficult to measure RCA accurately (Wasiuddin et al. 2007).



Figure A.1 Dynamic Wilhelmy plate device (Kringos 2007).

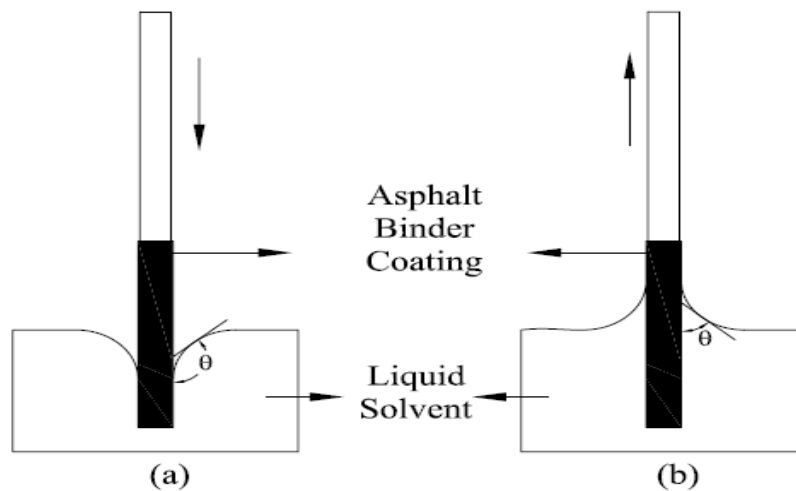

Figure A.2 Dynamic Wilhelmy plate method (DWPM): (a) advancing contact angle, (b) receding contact angle (Wasiuddin et al. 2007).

Three ACAs should be measured between the binder and three liquid solvents with known SFE characteristics (such as water, glycerin, and formamide). Known SFE characteristics means known Γ_L^{Total} , Γ_L^{LW} , Γ_L^+ , and Γ_L^- where the subscript (L) denotes liquid solvent. Each ACA along with the relevant liquid solvent SFE are substituted in the Young–Dupré equation given below:

$$\Gamma_L^{\text{Total}}(1 + \cos\theta) = 2 \times \sqrt{\Gamma_b^{\text{LW}}\Gamma_L^{\text{LW}}} + 2 \times \sqrt{\Gamma_b^-\Gamma_L^+} + 2 \times \sqrt{\Gamma_b^+\Gamma_L^-} \quad (\text{A. 2})$$

where

- $\Gamma_b^{LW}, \Gamma_b^-$ and Γ_b^+ = SFE components of binder
 $\Gamma_L^{Total}, \Gamma_L^{LW}, \Gamma_L^+$ and Γ_L^- = SFE components of liquid solvent
 θ = ACA

From the three liquid solvents, three equations with three unknowns ($\Gamma_b^{LW}, \Gamma_b^+$, and Γ_b^-) are obtained for calculating the binder SFE three components ($\Gamma_b^{LW}, \Gamma_b^-$ and Γ_b^+). On the other hand, many devices are used to calculate the aggregate SFE components such as the wicking method, micro calorimetry, and inverse gas chromatography (Bhasin et al. 2007b). The Universal Sorption Device (USD) (Bhasin et al. 2007a, 2007b, 2009) (Figure A.3) is used to measure the SFE components for aggregates.



Figure A.3 Universal sorption device (USD) (Bhasin et al. 2007b).

In this device, the aggregate sample is held in a special chamber, subjected to three different probe vapors, each with known SFE components. The adhesion between each probe vapor and the aggregate is given by the following equation:

$$W_{S,V}^a = 2\sqrt{\Gamma_s^{LW}\Gamma_v^{LW}} + 2\sqrt{\Gamma_s^+\Gamma_v^-} + 2\sqrt{\Gamma_s^-\Gamma_v^+} \quad (A.3)$$

where

- $\Gamma_s^{LW}, \Gamma_s^-$ and Γ_s^+ = SFE components of aggregate
 $\Gamma_v^{LW}, \Gamma_v^+$ and Γ_v^- = SFE components of liquid probe vapor
 $W_{S,V}^a$ = Work of adhesion (adhesion bond)

To obtain three linear equations with the aggregate, three SFE components as unknown, the $W_{S,V}^a$ between the aggregate, and each probe vapor are required. $W_{S,V}^a$ is calculated mathematically depending on the spreading pressure of the vapor on the aggregate surface (Bhasin et al. 2007b). Different types of probe vapors can be used such as n-hexane, methyl propyl ketone, and water.

After measuring the SFE components of both binder and aggregate, it is easy to calculate the aggregate-binder adhesion bond, the binder-binder cohesion bond, interfacial energy, and free energy released in the presence of moisture.

1. Aggregate–binder adhesion bond ($W_{S,b}^a$)

The adhesion bond between aggregate and binder is defined as the energy needed to form two surface areas from binder and aggregate, each of unit area. The adhesion bond is not only related to moisture damage, but also to other engineering performance aspects such as temperature stability and aging (Hao et al. 2006). The adhesion bond involves thermodynamic, physio-chemical, and mechanical aspects (Kringos et al. 2008a). The thermodynamic aspect involves wetting and the equilibrium of energies and forces at the aggregate-binder interface. The physio-chemical aspect involves the chemical bonding at the interface while the mechanical aspect involves the mechanical interlocking at the interface.

The adhesion bond between the aggregate and the binder can be determined using Equation A.3 by applying the SFE components for the aggregate and the binder as follows (Wasiuddin et al. 2007; Cheng et al. 2003; Bhasin et al. 2007a, 2007b, 2007c):

$$W_{S,b}^a = 2\sqrt{\Gamma_s^{LW}\Gamma_b^{LW}} + 2\sqrt{\Gamma_s^+\Gamma_b^-} + 2\sqrt{\Gamma_s^-\Gamma_b^+} \quad (\text{A. 4})$$

It is clear that the adhesion bond is dependent on the binder and aggregate properties (Hao et al. 2006).

2. Binder–binder cohesion ($W_{b,b}^a$)

The cohesion bond of binder is defined as the energy needed to form two surface areas of unit area in binder. This definition is the same for fracture energy. In other words, fracture energy can be measured using the SFE components. The cohesion of binder can be determined using Equation A.3 by applying the SFE components of the binder as follows (Bhasin et al. 2007a):

$$W_{b,b}^a = 2\sqrt{\Gamma_b^{LW}\Gamma_b^{LW}} + 2\sqrt{\Gamma_b^+\Gamma_b^-} + 2\sqrt{\Gamma_b^-\Gamma_b^+} = 2\Gamma_b^{LW} + 4\sqrt{\Gamma_b^+\Gamma_b^-} \quad (\text{A. 5})$$

It is obvious that the binder cohesion bond (or fracture energy) is equal to twice the SFE of binder (Bhasin et al. 2009).

3. Interfacial energy (Γ_{ij})

The interfacial energy between two materials, i and j, using their SFE components is calculated as follows (Bhasin et al. 2007a; Cheng et al. 2003; Bhasin et al. 2007b):

$$\Gamma_{ij} = \Gamma_i^{\text{Total}} + \Gamma_j^{\text{Total}} - 2\sqrt{\Gamma_i^{LW}\Gamma_j^{LW}} - 2\sqrt{\Gamma_i^+\Gamma_j^-} - 2\sqrt{\Gamma_i^-\Gamma_j^+} \quad (\text{A. 6})$$

where

$\Gamma_i^{\text{Total}}, \Gamma_j^{\text{Total}}$ = SFE for materials (i) and (j), respectively

$\Gamma_i^{\text{LW}}, \Gamma_i^+ \& \Gamma_i^-$ = SFE components for material (i)

$\Gamma_j^{\text{LW}}, \Gamma_j^+ \& \Gamma_j^-$ = SFE components for material (j)

4. Free energy released in the presence of moisture ($W_{\text{bsw}}^{\text{wet}}$)

Debonding the aggregate and binder in the presence of water follows Equation A.7 (Bhasin et al. 2007a; Cheng et al. 2003; Bhasin et al. 2007b):

$$W_{\text{bsw}}^{\text{wet}} = \Gamma_{\text{bw}} + \Gamma_{\text{sw}} - \Gamma_{\text{bs}} \quad (\text{A. 7})$$

where

Γ_{bw} = Interfacial energy between binder and water

Γ_{bs} = Interfacial energy between binder and aggregate

Γ_{sw} = Interfacial energy between aggregate and water

The above four parameters, $W_{\text{S,b}}^{\text{a}}, W_{\text{b,b}}^{\text{a}}, \Gamma_{\text{ij}}$, and $W_{\text{bsw}}^{\text{wet}}$, and SFE are material properties, i.e., they do not depend on the geometry or size of the material (Bhasin et al. 2007a). These four parameters are the main parameters used to evaluate moisture damage in asphalt concrete.

Generally, the dispersive component for binders varies from 12 to 35 ergs/cm² and for aggregates from 35 to 80 ergs/cm² (Bhasin et al. 2007b). Base components are higher than acid components for aggregates; for most binders, acid components are higher than base components. This difference between the aggregate and binder components contributes to the adhesion bond energy between the aggregate and binder (Wasiuddin et al. 2007; Bhasin et al. 2007b). The effect of additives and modifiers—when added to binders—can be studied by observing the SFE of binders. The additives neither significantly change nor improve the SFE of binders in a range varying from 20% to more than 200% (Wasiuddin et al. 2007; Bhasin et al. 2009). For example, the modifiers added to binders to increase the binders' performance grade (PG) improve the cohesion bond for binders, thus enhancing their fracture resistance.

Bhasin et al. (2007a, 2007b, 2007c) proposed the following ratios to evaluate moisture sensitivity for asphalt mixtures.

1. Compatibility ratio (ER_1)

The $W_{\text{bsw}}^{\text{wet}}$ parameter is an indicator of the propensity of water to replace bitumen from the aggregate surface, where high $W_{\text{bsw}}^{\text{wet}}$ means a high potential that water will cause debonding between aggregate and binder. For asphalt mixtures to be more moisture resistant, the adhesion between aggregate and binder should be at its highest while the $W_{\text{bsw}}^{\text{wet}}$ should be at its lowest (Bhasin et al. 2007a, 2007b). ER_1 was therefore introduced as follows (Bhasin et al. 2007a):

$$ER_1 = \left| \frac{W_{\text{S,b}}^{\text{a}}}{W_{\text{bsw}}^{\text{wet}}} \right| \quad (\text{A. 8})$$

where

- ER_1 = Compatibility ratio
- $W_{S,b}^a$ = Aggregate – binder adhesion bond
- W_{bsw}^{wet} = Free energy released in the presence of moisture

High (ER_1) is an indication of less free energy released in the presence of moisture and more adhesion bond between aggregate and binder and, therefore, more moisture resistance.

2. Modified compatibility ratio (ER_2)

$$ER_2 = \left| \frac{W_{S,b}^a - W_{b,b}^a}{W_{bsw}^{wet}} \right| \quad (A.9)$$

The cohesive bond is introduced to consider wettability, which is the ability of a material to wet the surface of another material, and, in this case, the ability of binder to wet the surface of aggregate. Wettability is related to the cohesion bond of binder, i.e. as the cohesion bond of binder increases, wettability decreases and vice versa. Low wettability indicates that the bond between binder and aggregate is not strong. Hence, as (ER_2) increases, moisture resistance increases.

Bhasin et al. (2007a, 2007b, 2007c) introduced specific surface area (SSA) of aggregate to ER_1 and ER_2 . A large SSA provides enough area for binder to bond and therefore better mechanical interlocking between aggregate and binder; hence, increase the moisture resistance of asphalt concrete. Accordingly, Equations A.8 and A.9 were modified as follows:

$$ER_1 \times SSA = \left| \frac{W_{S,b}^a}{W_{bsw}^{wet}} \right| \times SSA \quad (A.10)$$

$$ER_2 \times SSA = \left| \frac{W_{S,b}^a - W_{b,b}^a}{W_{bsw}^{wet}} \right| \times SSA \quad (A.11)$$

Bhasin et al. (2007a, 2009) conducted asphalt mixture dynamic modulus test and dynamic creep test in tension to compare the results of these mechanical tests with the results of SFE methodology through ER_1 and ER_2 parameters. A good correlation was reported between moisture sensitivity of asphalt mixtures and W_{bsw}^{wet} , and between asphalt mixtures moisture damage performance in the field and the laboratory with the parameters measured using SFE components of aggregate and binder.

4.2 DIFFUSION

Moisture damage occurs when moisture penetrates through asphalt pavement. Moisture transports through asphalt concrete primarily through three modes (Caro et al. 2008a):

1. Permeability of surface water
2. Suction (capillary rise and osmotic effect)
3. Water vapor diffusion

The source of surface water is either rainfall or drainage systems. Permeability is the ability of asphalt pavement to transmit moisture (Caro et al. 2008a). Permeability of asphalt concrete depends primarily on air void size, air void distribution, and pavement thickness. There are various lab and field test procedures for measuring permeability. Field tests include the field permeability testing device and tipping buckets. Laboratory permeability tests include the falling head test and constant head test.

Although the main source of moisture in asphalt pavements is surface water, severe moisture damage conditions could occur in areas having low annual rainfall levels, suggesting the significant effect of moisture coming from underneath. The source of moisture in the suction mode is subsurface water. Kassem et al. (2006) defined suction as “the measure of the free energy state of water in materials.” Generally, the suction of any material depends on the air void size, air void distribution, water content, and the ability of material to retain moisture (Kassem et al. 2006). As the air void size decreases, the suction increases and vice versa (Kassem et al. 2006). Suction comprises two components: matric suction and osmotic suction. Matric suction (or capillary) is caused by the surface tension of water while osmotic suction is caused by salt concentration in water (Kassem et al. 2006).

There are two methods for measuring suction: the wetting method and the drying method (Kassem et al. 2006). The drying method is more popular because it produces less variable results in a short period of time. The apparatus used to measure suction is called thermocouple psychrometer (Figure A.4). There are two types of psychrometers: the wet loop and the Peltier. The main concept in measuring suction is to measure the relative humidity in the air phase of the pores.

The above-mentioned transport modes only describe the mechanisms of how and where moisture is introduced in the asphalt concrete system. In order for this transported moisture to cause damage, it needs to travel through the asphalt binder or mastic. This movement mechanism is called diffusion. Diffusion along with relative humidity, storage rate, and capacity are the major factors affecting the amount of moisture accumulated in asphalt mixtures (Caro et al. 2008a). Generally, if moisture diffuses through the mastic toward the aggregate-binder interface, it will cause an adhesion failure, but if moisture diffuses only in the binder, it will cause a cohesive failure.

Diffusion is measured using the same two methods and the same apparatus used to measure suction. In order to eliminate the variability in measuring diffusion caused by air void distribution, sand asphalt specimens were used by Kassem et al. (2006). The air void distribution is uniform in sand asphalt specimens, and the measured diffusion is, therefore, more related to material property. The USD can also be used to measure diffusion for binder (Cheng et al. 2003).

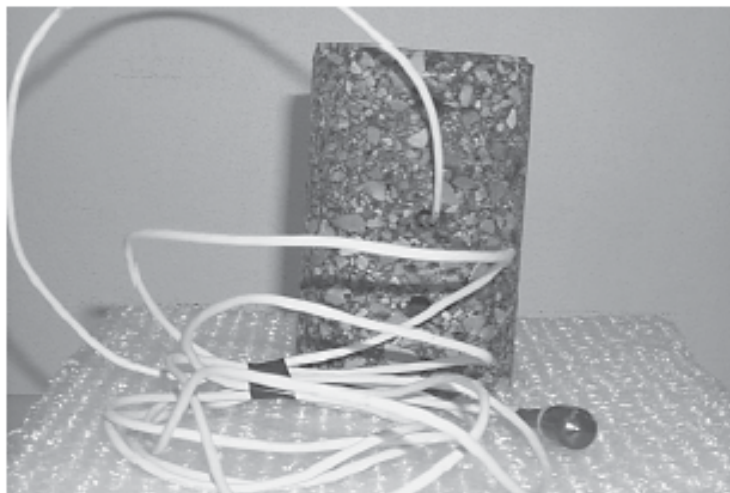

Figure A.4 An HMA sample with three thermocouple psychrometers installed (Kassem et al. 2006).

The relation between suction and diffusion with moisture damage is interesting. High suction in asphalt concrete samples indicates smaller air voids and, consequently, a limited ability to lose moisture for the binder–aggregate interface. This creates a slow diffusion rate across the asphalt film, or, in other words, less moisture damage. Likewise, low suction indicates larger air voids in asphalt concrete and, therefore, high susceptibility of air voids to lose the moisture for the binder–aggregate interface, leading to faster diffusion rate across the asphalt film. In short, high suction indicates a slow diffusion rate which limits moisture damage, whereas low suction indicates faster diffusion rate and higher moisture damage. It should be noted that neither extremely low nor high suction values are preferable; an optimum suction value should be determined to minimize moisture damage (Kassem et al. 2006).

The above relation was compared with mechanical test results for verification purposes. Cheng et al. (2003) conducted the repeated-load permanent deformation test and observed a consistency between these mechanical test results and measured diffusion values for asphalt mixtures with different moisture sensitivity levels.

5. MODELING

Mathematical modeling is used to understand moisture damage (Caro et al. 2008a). Modeling of moisture damage helps predict the behavior of asphalt concrete in the presence of moisture for any given environmental and traffic loading conditions and the approximate timing of different failure patterns (Kringos et al. 2008a). Modeling moisture damage also allows for a clear observation of how different properties of both components (aggregates and binder) and mixture affect moisture damage (Caro et al. 2008b). The modeling of moisture damage has become possible because of state-of-the-art computing programs and an understanding of the chemical and physical processes of moisture damage.

Two main aspects of moisture damage can be modeled: modes of moisture transport and the mechanism of failure modes. The main modes of moisture transport are permeability, suction, and vapor diffusion (Caro et al. 2008a).

As mentioned in Section 4, moisture diffusion through mastic is the key, regardless of the mode of transport. Diffusion causes two mechanism failure modes (Caro et al. 2008a; Kringos et al. 2008a): Adhesion and cohesive failures (Figure A.5).

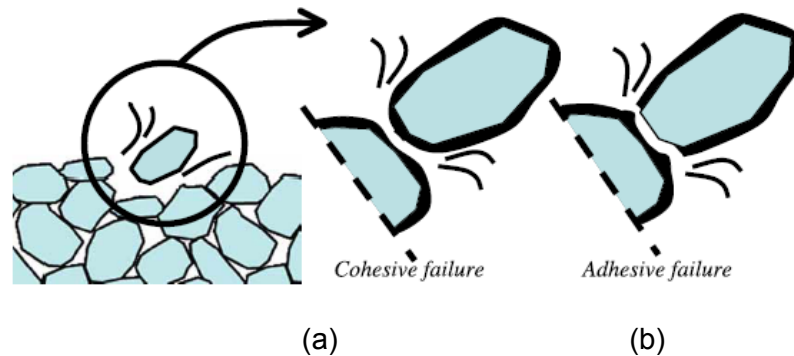

Figure A.5 Effect of moisture diffusion: (a) cohesive failure and (b) adhesive failure (Kringos et al. 2008a).

According to Kringos et al. (2008a), cohesive failure is caused by another physical process called washing away. Washing away is the loss of mastic particles or loss of mastic concentration as a result of fast water flow along with high water pressure gradient. Other nomenclatures for this failure mode are scouring and erosion (Figure A.6). The rate of washing away is related to mastic diffusion properties (Caro et al. 2008b).

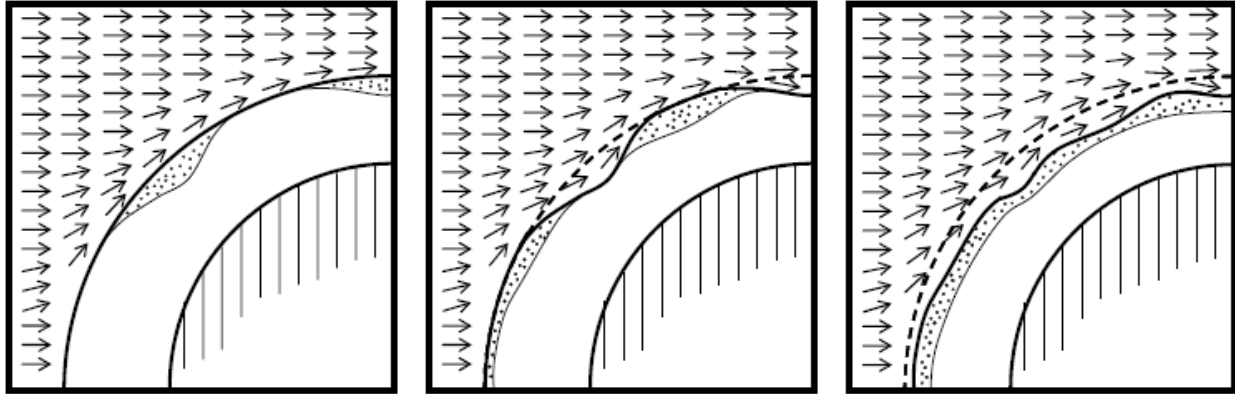

Figure A.6 Mastic erosion caused by fast flowing water (Kringos et al. 2008a).

The pumping action failure mode appears in the condition of traffic loading applied over saturated air voids (Kringos et al. 2008a). The passing load forms high pore pressure on the surrounding aggregates, thus causing additional damage. This mechanism mode is considered a mechanical process because it is directly related to the applied load (Figure A.7).

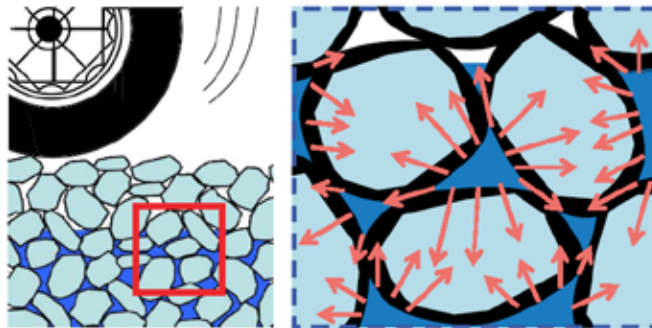

Figure A.7. Pumping action mechanism (Kringos et al. 2008a).

The X-ray computed tomography (CT) technology along with imaging analysis-related techniques assisted in modeling different modes of moisture transport (Figure A.8). Permeability, or moisture flow, was modeled using finite difference techniques and the Lattice Boltzmann approach (Caro et al. 2008b). Both approaches determined the flow speed and pore pressure at any point along the void structure of asphalt concrete. The main findings of these modeling approaches are (Caro et al. 2008b):

1. Horizontal permeability was approximately twice as great as vertical permeability.
2. Horizontal permeability was clear in regions with connected air voids.
3. Regions with low concentration of air voids acted as “bottleneck” for vertical permeability.
4. There was a significant change in pore pressure and flow speed along the depth of asphalt concrete.

These findings are attributed to the heterogeneity and non-uniform distribution of air voids inside asphalt concrete.

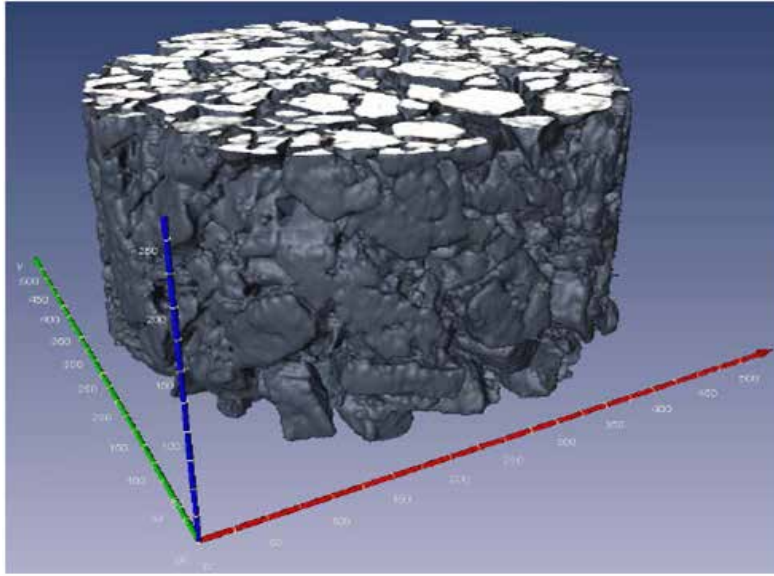

Figure A.8 3D X-ray CT with imaging analysis technique (Kutay et al. 2007).

Kringos et al. (2008a) also performed modeling for moisture flow, diffusion, and erosion processes. The following relations were established.

1. Moisture flow

$$\sum_{j=1}^n \left(\int_V N_i L(h) N_j dV \right) \frac{dh_j}{dt} + \sum_{j=1}^n \left(\int_V \nabla N_i \underline{K} \nabla N_j dV \right) = \int_S N_i \underline{K} (\nabla h + \nabla z) dS - \int_V \nabla N_i \underline{K} \nabla z dV \quad (\text{A. 12})$$

where

- N_i, N_j = shape functions
- L = storage coefficient
- h = pressure head
- \underline{K} = intrinsic permeability tensor of element
- z = datum
- dS = surface area of element.
- dV = volume of element

Equation A.12 can also be written in the following matrix form:

$$[m] \left\{ \frac{dh}{dt} \right\} + [S] \{h\} = \{B\} + \{G\} \quad (\text{A.13})$$

2. Diffusion

$$\theta = \frac{C_m}{C_m^{max}} \quad (\text{A.14})$$

$$J_{\omega_d} = -D_{\omega} \nabla C_m \quad (\text{A.15})$$

$$D_{\omega} = a_m \tau \delta_{ij} \quad (\text{A.16})$$

where

- θ = moisture content
- C_m = current moisture concentration
- C_m^{max} = maximum moisture concentration
- J_{ω_d} = diffusion flux
- D_{ω} = diffusion/dispersion tensor
- a_m = diffusion coefficient
- τ = tortuosity
- δ_{ij} = Kronecker delta

The amount of moisture mass in mastic at time (t) is dependent on the diffusivity which is represented by the diffusion coefficient and the maximum moisture concentration.

3. Washing away

$$\begin{aligned} & \sum_{j=1}^n \left(\int_V N_i (\theta + \rho_0^m K_d) N_j dV \right) \frac{dC_j^d}{dt} + \sum_{j=1}^n \left(\int_V (\nabla N_i D_{\omega} \nabla N_j) dV \right) C_j^d \\ & + \sum_{j=1}^n \left(\int_V N_i \alpha * \frac{\partial hh}{\partial t} (\theta + \rho_0^m K_d) N_j dV \right) C_j^d - \sum_{j=1}^n \left(\int_V N_i \left(\alpha * \frac{\theta}{\phi} \frac{\partial hh}{\partial t} \right) N_j dV \right) C_j^d \\ & = \int_S N_i n_{\omega} D_{\omega} \nabla C_d dS \end{aligned} \quad (\text{A.17})$$

where:

- N_i, N_j = shape functions
- θ = moisture content
- ρ_0^m = undamaged mastic density
- K_d = mastic desorption coefficient
- dS = surface area of element
- dV = volume of element
- C_j^d = dissolved mastic concentration at node (j)
- \underline{D}_m = diffusion tensor
- ϕ = porosity
- α = compressibility coefficient of the material
- h = head pressure
- \underline{n} = outward unit normal

Equation A.17 can also be written in a matrix form as follows:

$$[m] \left\{ \frac{dC_d}{dt} \right\} + ([D] + [K]) \{C_d\} = \{Q\} + \{B\} \quad (\text{A. 18})$$

Equations A.12 through A.18 are applied on the mesh shown in Figure A.9.

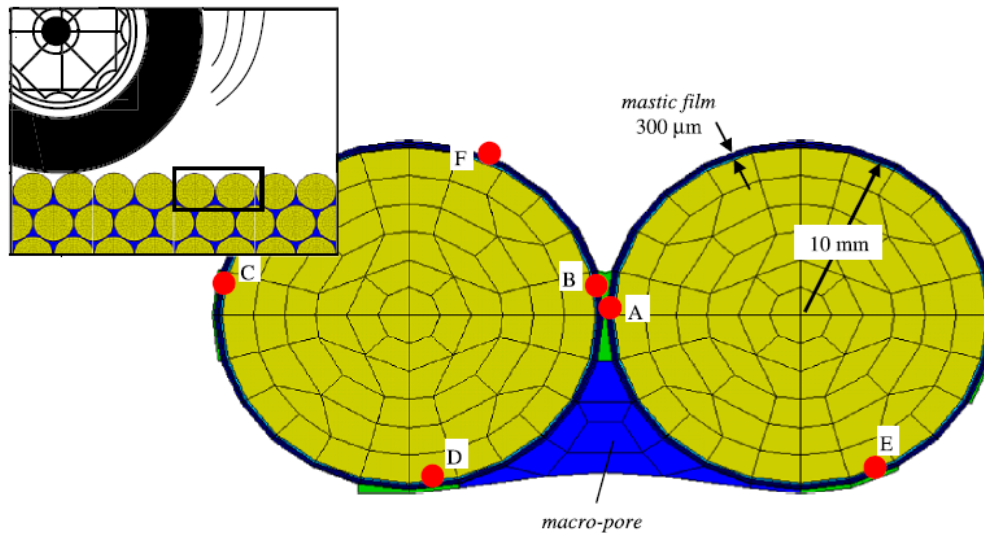

Figure A.9 Finite element mesh for modeling moisture damage (Kringos et al. 2008b).

This micro-scale finite element model was used to simulate the moisture-induced damage caused by the different processes mentioned above. The simulation model consists of two particles of aggregates coated with mastic and has fully saturated pores which were simulated as porous media formulation. In order to simulate the diffusion effect on the bond, the aggregate-mastic interface was also modeled in this simulation.

To determine whether the moisture-induced damage is in the mastic or at the aggregate-mastic bond interface, it is necessary to measure the moisture diffusion coefficient of mastic (Kringos et al. 2008a). The coefficient of mastic sorption test was conducted to determine moisture diffusion. In this test, a small sample of mastic was placed in a chamber and subjected to moisture vapor. The weight of the mastic sample was known and recorded before and during the test. The difference in weight is caused by the moisture diffusing through the mastic sample. The diffusion coefficient of mastic is therefore determined.

Kringos et al. (2008a, 2008b) developed a finite element routine called Raveling of Asphalt Mixes (RoAM) in The Delft University of Technology, The Netherlands. The RoAM routine is a part of the CAPA-3D finite element software. Equations A.12 through A.18 are embedded in this routine, which reflects a numerical simulation of diffusion that results in adhesive failure, cohesive failure, and washing away failure. This routine also simulates the pumping action failure mode. The most interesting feature of this routine is that it exclusively models and analyzes moisture damage.

The modeling of moisture damage needs further study and development. Other factors can be introduced in the future modeling process such as simulating the effect of additives on asphalt mixtures, reducing the number of assumptions through using measured parameters, and considering various environmental and traffic loading conditions.

6. ADDITIVES/MODIFIERS

There are three forms of asphalt binder modification (Bhasin et al. 2009):

1. Performance grade (PG) modification: Polymers are generally added to binder to increase its PG, especially the high temperature part. This modification is in accordance with the Superpave® specifications. The original binder (before modification) is called base binder.
2. Mixture performance modification: Enhancing asphalt mixture performance by adding special material to binder such as liquid anti-strip agent. The main goal of adding the liquid anti-strip is to increase the moisture resistance of the asphalt mixture. Materials can be added to base binders or to binders that are already modified.
3. Environmental modification (e.g., asphalt concrete aging): Aging leads to changes in the chemistry and mechanical properties of asphalt binder.

Additives and modifiers are considered two of the most cost-effective measures used to mitigate moisture damage. Performance grade and mixture performance modifications generally increase the bond energy between the binder and aggregate by decreasing the surface tension of binder (Expert Task Group 1990). Additives such as hydrated lime can be added to binder or aggregate.

When designing an asphalt mixture and an additive or a modifier needs to be chosen to reduce the moisture damage affect, the following should be taken into consideration (Expert Task Group 1990):

1. Dosage: Amount to be added to the mix
2. Economics: Availability and cost effectiveness
3. Effect of this modification on adhesive and other mixture properties

Many additives were developed that can be added to asphalt mixtures. The primary aim of using additives is to reduce moisture sensitivity and stripping. These additives can be found naturally or are chemically processed. The following additives are the most commonly used in the United States:

1. Hydrated lime
2. Liquid anti-strip
3. Polymer modification (SBS)
4. Polyphosphoric acid (PPA)

6.1 HYDRATED LIME

Lime additive has been used in asphalt mixtures since 1910. Hydrated lime resists stripping by increasing the adhesion energy between the aggregate and binder by decreasing the interfacial tension between the binder and water. This stripping resistance can be chemically described as the hydrated lime reacting with the carboxylic acids in binder, forming insoluble compounds that are absorbed by the aggregate surface. Hydrated lime is added to asphalt mixtures by any of the four following methods:

1. Dry hydrated lime to dry aggregate: In this method, dry hydrated lime is first added to the aggregate and then the binder is added to the mixture. However, a significant amount of

hydrated lime is lost from the surface of aggregate, especially in the drum before the binder is added.

2. Hydrated lime slurry: The hydrated lime is added to aggregate and then marinated by adding water to this composition. After the marinating process, the aggregate enters the heating process and then the binder is added. However, an additional cost of fuel is incurred in this method for extracting the additional amount of water added for the marinating process.
3. Dry hydrated lime with moist aggregate: This method differs from the hydrated lime slurry method in that the aggregate water content is increased by 3% to 5%, and then hydrated lime is added to this moist aggregate for marinating. This composition then enters the plant for heating and the binder is added for mixing.
4. Hot slurry: In this method, the hydrated lime is heated before it is added to the aggregate. Then water is added, followed by the binder. This method is considered very hazardous and affects the safety of plant workers due to adding water to the hot hydrated lime and aggregate.

Hydrated lime dosage ranges between 0.5% and 2% by the weight of aggregate (Expert Task Group 1990). Adding hydrated lime to asphalt mixtures increases its cost by approximately \$2 to \$4 per ton (Expert Task Group 1990). The overall performance of hydrated lime is acceptable in the field, but its effectiveness depends on the type of aggregate and binder used in the mix. The hydrated lime is not effective when it is added to some types of aggregates. The method of adding hydrated lime to the asphalt mixture also affects the overall asphalt concrete performance (Expert Task Group 1990).

6.2 LIQUID ANTI-STRIP

There are many types of liquid anti-strip additives, but most of them are considered surface-active agents. The selection of the type and amount of liquid anti-strips should be based on the specific mixing conditions and the kind of mix the liquid anti-strip is added to (asphalt binder, emulsion, or cutback). When added to asphalt mixture, the liquid anti-strip contributes to the reduction of the surface tension of asphalt binder and, consequently, to the increase of adhesion between the aggregate and the binder. In other words, adding liquid anti-strip increases the wettability of aggregate, meaning that the aggregate will be more easily wetted by asphalt binder.

Generally, the dosage of liquid anti-strips ranges between 0.1% and 3% by weight of asphalt binder (Expert Task Group 1990). The dosage of liquid anti-strip differs from one mix to another because of the different properties of binder and aggregate found in each mix. Liquid anti-strip is added by two methods: a) it is added to the asphalt binder before mixing it with the aggregate, or b) it is added to the aggregate before adding the binder. Because the liquid anti-strip needs to be efficient and provide the user with the best benefits, most of the added liquid anti-strips should be at the interfacial region between the aggregate and binder. Therefore, it is obvious that adding the anti-strip to the aggregate assures the presence of anti-strip at the interface more than the first method. The movement of liquid anti-strip through the binder to reach the interface is not easy and depends on the viscosity of the binder.

Many transportation agencies reported a difference between the asphalt mixture performances with liquid anti-strip in the field versus in the laboratory. This finding may be attributed to any of the following (Expert Task Group 1990):

1. The liquid anti-strip is not properly mixed with the binder
2. The use of wet aggregate

3. Improper dosage amount or improper type of liquid anti-strip
4. The moisture evaluation tests conducted in the laboratory are not representative enough
5. Lack of heat stability.

6.3 POLYMER MODIFICATION

The use of binders modified with styrene-butadiene-styrene (SBS) polymer is one of the methods used to produce an asphalt concrete mixture that is more stripping resistant. The chemical structure of SBS consists of styrene ($C_6H_5 - CH = CH_2$)_n, butadiene ($CH_2 = CH - CH = CH_2$)_n, and styrene ($C_6H_5 - CH = CH_2$)_n, where subscript (n) represents the number of repeating units in the polymer molecule (Tarefder et al. 2009). When (n) is equal to 1, the polymer is called SBS monomer. The combination of many monomers forms a polymer. Polymer molecules can be simply linearly chained where the monomers are aligned in one linear fashion, or cross-linked when several linear chains bond together in three dimensions (Tarefder et al. 2009).

Regarding the setting characteristics, polymers are classified as thermosetting polymers and thermoplastic polymers. SBS is considered a thermoplastic polymer; under high temperatures it softens and becomes workable and can be easily added and mixed with asphalt binder. At room temperature, the SBS has rubber-like properties, and when cooling, the SBS hardens and maintains its shape and loses the rubber properties (Tarefder et al. 2009). The only way to add polymer to asphalt mixture is by adding it to a heated asphalt binder (approximately 190°C) and then mixing the modified binder for a period of two hours in a special mixer to assure the proper and homogenous distribution of the polymer.

6.4 POLYPHOSPHORIC ACID (PPA)

Polyphosphoric acid (PPA) is a liquid mineral polymer that has many applications in different sectors of industry. One of these applications is asphalt modification. The asphalt modification not only includes the enhancement of asphalt concrete to resist moisture effects, but also includes the improvement of high temperature performance grade and, for a few asphalt binder types, the improvement of low temperature performance grade. PPA can be used exclusively or with other polymers such as SBS or other additives such as hydrated lime or liquid anti-strip.

Care should be taken when using PPA with liquid anti-strip additives because a neutralization reaction may occur as a result of PPA reacting with some types of liquid anti-strips; this means that the asphalt binder loses its stiffness but not its adhesion properties (Buncher 2010). Different results are observed with the hydrated lime additive because PPA does react with lime. Additionally, PPA does not react efficiently with limestone aggregates, while it is very efficient with acidic aggregate types such as granite (Buncher 2010).

Although this literature review covers four additives only, more additives are used in the United States. Other additives used include Portland cement, fly ash, and flue dust. As a rule of thumb, the effectiveness of any additive depends on the type of binder and aggregate used in the asphalt mixture.

The performances of the four additives, mentioned above, to reduce mixture moisture damage need to be explored. The performances of hydrated lime and liquid anti-strip were compared (Sebaaly et al. 2007; Peiwen et al. 2006; Lu et al. 2006). It was observed that both hydrated lime and liquid anti-strip improve asphalt concrete moisture damage resistance in short-term aging. The hydrated lime-treated mixtures was found to improve the moisture resistance on the short- and long-term (Sebaaly et al. 2003; Kim et al. 2008; Huang et al. 2009; Mohammad et al. 2008). The moisture resistance of asphalt mixtures with liquid anti-strip appeared to decrease in long-term aging. Other

studies proved that adding liquid anti-strip increases the adhesion energy between the binder and aggregate, thus creating more moisture resistant mixtures (Wasiuddin et al. 2007; Bhasin et al. 2007b, 2009). If not used with proper binder and aggregate types, the liquid anti-strip will not mitigate moisture susceptibility and, in some cases, may increase damage (Bhasin et al. 2009). It was observed that SBS additive increases moisture resistivity when added to unaged and aged binder (Tarefder et al. 2009; Bhasin et al. 2009). In general, the long-term performance of many additives is still unclear because of the lack of long-term performance data (Expert Task Group 1990).

7. SUMMARY

Moisture damage is the degradation of the mechanical properties of asphalt mixtures caused by moisture. Moisture damage is very complex because of time-dependent variables such as environmental conditions, traffic loading, properties of aggregate, properties of binder, and properties of asphalt mixture. The complexity is also attributed to the fact that moisture damage involves mechanical, physio-chemical, and thermodynamic processes. The moisture damage occurs due stripping, binder softening, and aggregate degradation.

Moisture damage laboratory tests started in the 1930s, and the process of developing new test procedures continues. Developing laboratory moisture damage evaluation tests is challenging. It is difficult to simulate field performance because of the high variability of the factors affecting moisture damage. Laboratory evaluation tests can be classified according to their sample type (loose or compacted), conditioning process, scale of performance (macro or micro) and type of loading. The tests can also be classified according to the nature of the outcome obtained, such as visual inspection, measuring index, and measuring moisture damage ratio.

Methods such as surface-free energy and simulation of modes of moisture transport, diffusion, have recently been introduced. Parameters such as adhesion energy, cohesion energy, and free energy released in the presence of moisture can be used to assess the asphalt mixtures susceptibility to moisture. Mathematical modeling of moisture damage has been also used to assist in predicting the field performance of asphalt mixtures and to better understand the contribution of binder, aggregate, and asphalt mixture to moisture damage. Finally, the literature review discussed the performance and effectiveness of some additives and modifiers used to control asphalt mixture's moisture damage including hydrated lime, liquid anti-strip, polymer modification (SBS), and polyphosphoric acid (PPA).

REFERENCES

- Bhasin, A., E. Masad, D. Little, and R. L. Lytton. Limits on Adhesive Bond Energy for Improved Resistance of Hot-Mix Asphalt to Moisture Damage. In *Transportation Research Record: Journal of the Transportation Research Board*, No. 1970, Transportation Research Board of the National Academies, Washington, D.C., 2006, pp. 3–13.
- Bhasin, A., D. N. Little, K. L. Vasconcelos, and E. Masad. Surface Free Energy to Identify Moisture Sensitivity of Materials for Asphalt Mixes. In *Transportation Research Record: Journal of the Transportation Research Board*, No. 2001, Transportation Research Board of the National Academies, Washington, D.C., 2007, pp. 37–45.
- Bhasin, A., and D. N. Little. Characterization of Aggregate Surface Energy Using the Universal Sorption Device. *Journal of Materials in Civil Engineering*. Vol. 19, No. 8, 2007, pp. 634–64.
- Bhasin, A., J. Howson, E. Masad, D. Little, and R. Lytto. Effect of Modification Processes on Bond Energy of Asphalt Binders. In *Transportation Research Record: Journal of the Transportation Research Board*, No. 1998, Transportation Research Board of the National Academies, Washington, D.C., 2007, pp. 29–37.
- Bhasin, A., and D. Little. Application of Microcalorimeter to Characterize Adhesion Between Asphalt Binders and Aggregates. *Journal of Materials in Civil Engineering*. Vol. 21, No. 6, 2009, pp. 235–243.
- Birgisson, B., R. Roque, G. C. Page, and J. Wang. Development of New Moisture-Conditioning Procedure for Hot-Mix Asphalt. In *Transportation Research Record: Journal of the Transportation Research Board*, No. 2001, Transportation Research Board of the National Academies, Washington, D.C., 2007, pp. 46–55.
- Buncher, M. Establishing a Baseline of Knowledge (through 2005) by Reviewing AI IS-220 “Polyphosphoric Acid Modification of Asphalt.” Presented at the Annual Conference of the American Association of Paving Technologists, 2010.
- Caro, S., E. Masad, A. Bhasin, and D. N. Little. Moisture Susceptibility of Asphalt Mixtures, Part 1: Mechanisms. *International Journal of Pavement Engineering*. Vol. 9, No. 2, 2008(a), pp. 81–98.
- Caro, S., E. Masad, A. Bhasin, and D. N. Little. Moisture Susceptibility of Asphalt Mixtures, Part 2: Characterisation and Modelling. *International Journal of Pavement Engineering*. Vol. 9, No. 2, 2008(b), pp. 99–114.
- Cheng, D. X., D. N. Little, R. L. Lytton, and J. C. Holste. Moisture Damage Evaluation of Asphalt Mixture by Considering both Moisture Diffusion and repeated Load Conditions. In *Transportation Research Record: Journal of the Transportation Research Board*, No. 1832, Transportation Research Board of the National Academies, Washington, D.C., 2003, pp. 42–58.
- Cho, D., T. S. Lee, S. Lee, and H. U. Bahia. Comparison of Linear Visco-Elastic Complex Modulus and Yield Shear Stress in DSR Moisture Damage Test. *Journal of Testing and Evaluation*. Vol. 37, No. 6, 2009.
- Cho, D.-W., and H. U. Bahia. Effects of Aggregate Surface and Water on Rheology of Asphalt Films. In *Transportation Research Record: Journal of the Transportation Research Board*, No. 1998, Transportation Research Board of the National Academies, Washington, D.C., 2007, pp. 10–17.
- Expert Task Group, Federal Highway Administration. *Moisture Damage in Asphalt Mixtures—A State-of-the-Art Report*. Publication FHWA-RD-90-019. FHWA, U.S. Department of Transportation, 1990.

- Hao, P., and H. Liu. Effect of Bitumen Acid Number on Moisture Susceptibility of Asphalt Mixtures. *Journal of Testing and Evaluation*. Vol. 34, No.4, 2006.
- Huang, J. F., S. P. Wu, L. X. Ma, and Z. F. Liu. Material Selection and Design for Moisture Damage of HMA Pavement. *Materials Science Forum*. Vol. 614, 2009, pp. 269–274.
- Kassem, E., E. Masad, R. Bulut, and R. Lytton. Measurements of Moisture Suction and Diffusion Coefficient in Hot Mix Asphalt and Their Relationships to Moisture Damage. In *Transportation Research Record: Journal of the Transportation Research Board*, No. 1970, Transportation Research Board of the National Academies, Washington, D.C., 2006, pp. 45–54.
- Kim, Y. R., J. S. Lutfi, A. Bhasin, and D. N. Little. Evaluation of Moisture Damage Mechanisms and Effects of Hydrated Lime in Asphalt Mixtures Through Measurements of Mixture Component Properties and Performance Testing. *Journal of Materials in Civil Engineering*. Vol. 20, No. 10, 2008, pp. 659–667.
- Kringos, N., 2007. Modelling of Combined Physical–Mechanical Moisture-Induced Damage in Asphaltic Mixes. Doctoral dissertation, Delft University of Technology, 2009.
- Kringos, N., T. Scarpas, C. Kasbergen, and P. Selvadurai. Modelling of Combined Physical–Mechanical Moisture-Induced Damage in Asphaltic Mixes, Part 1: Governing Processes and Formulations. *International Journal of Pavement Engineering*. Vol. 9, No. 2, 2008(a), pp.115–128.
- Kringos, N. A. Scarpas, A. Copeland, and J. Youtcheff. Modelling of Combined Physical–Mechanical Moisture-Induced Damage in Asphaltic Mixes, Part 2: Moisture Susceptibility Parameters. *International Journal of Pavement Engineering*. Vol. 9, No. 2, 2008(b), pp. 129–151.
- Kutay, M. E., A. H. Aydilek, and E. Masad. Computational and Experimental Evaluation of Hydraulic Conductivity Anisotropy In Hot-Mix Asphalt. *International Journal of Pavement Engineering*. Vol. 8, No. 1, 2007, pp:29–43.
- Little, D. N., and A. Bhasin. *Using Surface Energy Measurements to Select Materials for Asphalt Pavement*. NCHRP Project 9-37. National Cooperative Highway Research Program, Transportation Research Board of the National Academies, Washington, D.C., 2006.
- Lu, Q., and J. T. Harvey. Long-Term Effectiveness of Antistripping Additives: Laboratory Evaluation. In *Transportation Research Record: Journal of the Transportation Research Board*, No. 1970, Transportation Research Board of the National Academies, Washington, D.C., 2006, pp. 14–24.
- Mohammad, L. N., S. Saadeh, M. Kabir, A. Othman, and S. Cooper. Mechanistic Properties of Hot-Mix Asphalt Mixtures Containing Hydrated Lime. In *Transportation Research Record: Journal of the Transportation Research Board*, No. 2051, Transportation Research Board of the National Academies, Washington, D.C., 2008, pp. 49–63.
- Peiwen, H., and L. A. HongYing. Laboratory Study of the Effectiveness of Various Additives on Moisture Susceptibility of Asphalt Mixtures. *Journal of Testing and Evaluation*. Vol 34, No. 4, 2006, pp. 261–268.
- Sebaaly, P. E., E. Hitti, and D. Weitzel. Effectiveness of Lime in Hot-Mix Asphalt Pavements. In *Transportation Research Record: Journal of the Transportation Research Board*, No. 1832, Transportation Research Board of the National Academies, Washington, D.C., 2003, pp. 33–41.
- Sebaaly, P. E., D. Little, E. Y. Hajj, and A. Bhasin. Impact of Lime and Liquid Antistrip Agents on Properties of Idaho Hot-Mix Asphalt Mixture. In *Transportation Research Record: Journal of the Transportation Research Board*, No. 1998, Transportation Research Board of the National Academies, Washington, D.C., 2007, pp. 65–74.

- Tarefder, R. A., and A. M. Zaman. Nanoscale Evaluation of Moisture Damage in Polymer Modified Asphalts. *Journal of Materials in Civil Engineering*. Vol. 22, No. 7, 2010, pp. 714–725.
- Terrel, R. L., and S. Al-Swailmi. *Water Sensitivity of Asphalt–Aggregate Mixes: Test Selection*. Publication SHRP-A-403, National Research Council, 1994.
- Wasiuddin, N. M., C. M. Fogel, M. M. Zaman, and E. A. O’Rear. Effect of Anti-Strip Additives on surface Free Energy Characteristics of Asphalt Binders for Moisture-Induced Damage Potential. *Journal of Testing and Evaluation*. Vol. 35, No. 1, 2007, pp. 36–44.

